



# OPERATION, CARE AND MAINTENANCE MANUAL

For windows, doors, sliding & folding doors

**R**  
**REYNAERS**  
aluminium

# INDEX

<b>1. WARNINGS FOR INCORRECT USE.....</b>	<b>4</b>
1.1. Product information.....	5
1.2. Incorrect use of sashes.....	5
1.3. Incorrect use of handles.....	6
1.4. Incorrect use of locks.....	7
<b>2. OPERATION OF WINDOWS.....</b>	<b>8</b>
2.1. Opening types.....	9
2.1.1. Turn & tilt window.....	9
2.1.2. Tilt before turn window.....	10
2.1.3. Side hung window opening inward.....	11
2.1.4. Double casement window.....	12
2.1.5. Bottom hung window opening inward.....	13
2.1.6. Side hung window opening outward.....	14
2.1.7. Top hung window opening outward.....	14
2.1.8. Top hung outward projecting window.....	15
2.1.9. Parallel outward opening window.....	15
2.1.10. Vertical pivoting window.....	16
2.1.11. Horizontal pivoting window.....	16
2.1.12. Sliding window.....	17
2.1.13. Folding window.....	18
2.1.14. Roof window.....	19
2.1.15. Ventalis.....	19
2.2. Accessories for windows.....	20
2.2.1. Window handles.....	20
2.2.2. Opening limiter.....	21
2.2.3. Ventilation slid.....	22
2.2.4. Balcony door snapper.....	22
2.2.5. Built on lock.....	23
<b>3. OPERATION OF DOORS.....</b>	<b>24</b>
3.1. Opening types.....	25
3.1.1. Single doors.....	25
3.1.2. Double doors.....	26
3.1.3. Pivoting doors.....	27
3.1.4. Sliding doors.....	28

3.1.5. Hi-Finity sliding door.....	29
3.1.6. Lift sliding doors.....	30
3.1.7. Folding doors.....	32
3.1.8. Thermofront.....	33
<b>3.2. Accessories for doors.....</b>	<b>34</b>
3.2.1. Locking and unlocking of single doors.....	34
3.2.2. Locking and unlocking of double doors.....	35
3.2.3. Locking and unlocking panic doors / escape doors.....	36 - 37
3.2.4. Door closer.....	38
3.2.5. Restrictor lock.....	38
3.2.6. Door stop.....	39
<b>4. CARE AND MAINTENANCE.....</b>	<b>40</b>
4.1. General instructions for cleaning and maintenance.....	41
4.2. Maintenance interval.....	42
4.3. Overall maintenance.....	43
4.3.1. Maintenance of Drainage slots.....	43
4.3.2. Maintenance of rails in sliding and lift- and slide elements.....	43
4.3.3. Maintenance of gaskets.....	43
4.3.4. Maintenance of hardware and accessories.....	44
4.3.5. Maintenance of electrical components.....	45
4.4. Cleaning and maintenance of windows.....	46
4.4.1. Turn & tilt, turn and tilt & turn.....	46
4.4.2. Windows with friction stay.....	47
4.5. Cleaning and maintenance of doors.....	48
4.5.1. Single & double doors.....	48 - 49
4.5.2. Sliding door.....	50 - 51
4.6. Cleaning and maintenance of other systems.....	52
4.6.1. Ventalis.....	52
4.6.2. GP 51.....	52
4.7. Care products.....	53
<b>5. IMPORTANCE OF CLIMATE CONTROL AND VENTILATION.....</b>	<b>56</b>
5.1 Air tightness combined with good ventilation.....	57
5.2 Ventilation and climate control.....	57
<b>6. RECOMMENDATIONS.....</b>	<b>58</b>

# 1. WARNINGS FOR INCORRECT USE

## 1.1. PRODUCT INFORMATION

- Windows, doors, sliding systems and folding doors should be installed in a vertical plane. Only dedicated systems with specific hardware can be installed in a slanted position.
- When closing a window, it may be necessary to overcome the resistance of a sealing gasket. Other forms of resistance or obstruction cannot be considered as normal use.
- Special hardware is required for windows with high security against burglary.
- Open windows only have a screening purpose and do not comply with the requirements of wind and water tightness, sound proofing, thermal insulation and high security against burglary.
- In case of wind and draught, windows and doors should be closed to prevent slamming of the vent causing damage or injury.
- A fixed position of the window and door sashes should only be attained with dedicated hardware as described further in this manual.

## 1.2. INCORRECT USE OF SASHES



Risk of injury by getting stuck between window or door sash and frame.



Danger of falling through if sashes are open.



Danger of falling objects and/or related injury, e.g. caused by drafts.



Risk of injury caused by sash impact.



Risk of injury caused by sash impact when sashes are left open.



Load on the sashes or leaves can cause damage, deformation or destruction of the individual elements.

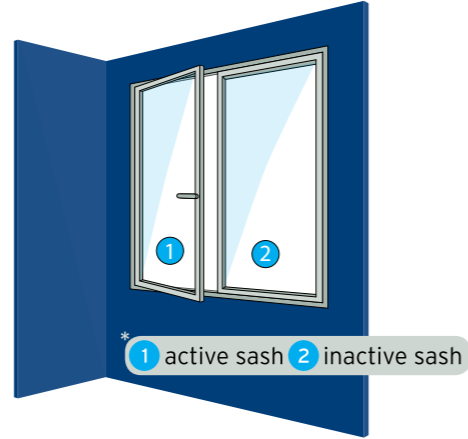

In case of double-leaf elements, the active sash must always be opened first (except escape doors) to avoid damage to the lock or frame.

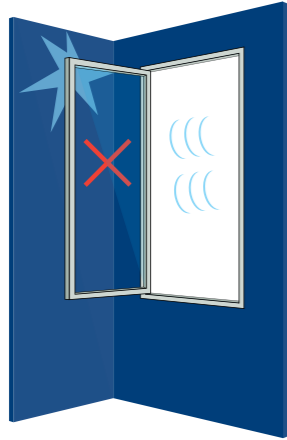

Sashes or leaves banging open in an uncontrolled manner (e.g. caused by wind) against wall recesses can damage the frame, fittings or the recess. Recommendation: use an opening limiter (regulates the opening distance) or a door stop.



Obstacles (e.g. cables, flower pots) in the opening area between sash and frame can cause deformation and damage to frames and fittings.



### 1.3. INCORRECT USE OF HANDLES

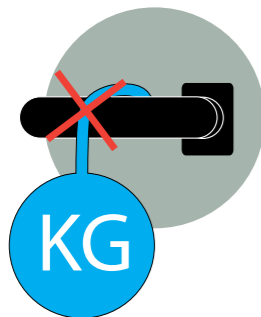

Load on the handle can cause damage to the locking mechanism.

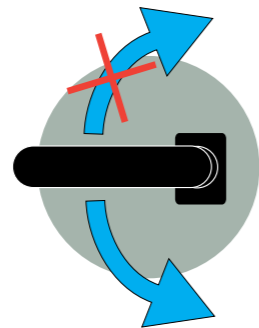

Operate the element handles only in the direction of the arrow as indicated in the manual and only up to the rotation stop. The handle and operating mechanism can be damaged otherwise.

### ANTI-ERROR DEVICE

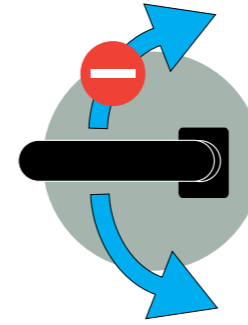

The anti-error device assures the correct operation of the handle by blocking any incorrect movements to avoid dangerous situations. The device blocks the movement of the handle to the next position, unless the window sash is completely pushed to the frame.



### 1.4. INCORRECT USE OF LOCKS



Never drill the fitting when the lock has been installed.

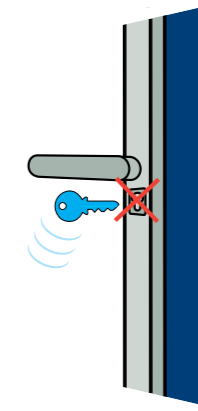

Do not force the lock in case of tightness or sluggish operation. Instead, the cause of the problem should be assessed and fixed by a professional.

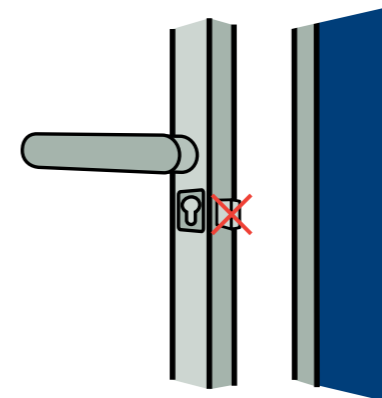

Do not close the door when the bolt is pre-locked: this will damage the lock and the door frame.



In case of a mechanical drive system, please observe the operating and maintenance instructions provided by the drive manufacturers.

## 2. OPERATION OF WINDOWS



Please observe the safety remarks indicated on p. 5 - 7



### 2.1. OPENING TYPES

#### 2.1.1. TURN & TILT WINDOW

By operating the handle of a turn and tilt window, the window can first be opened inwards completely and in second position, the window can be opened in ventilation position.





### 2.1.2. TILT BEFORE TURN WINDOW

Operating the handle of the tilt before turn window will first allow the window to tilt for ventilation purposes. In second position the window can be opened completely inwards.

A specific application of the tilt before turn mechanism is realized in combination with a lockable handle: this handle will always allow the tilt position for ventilation, but will prevent unauthorized persons from opening the window completely.



### 2.1.3. SIDE HUNG WINDOW OPENING INWARD

By operating the handle, the window sash can be opened for inward turning.

A handle position with the handle pointing upwards is not possible.





## 2.1.4. DOUBLE CASEMENT WINDOW

A double casement window consists out of 2 sashes with a specific opening sequence. The handle is mounted on the active sash. This active sash can be equipped with a side hung, a turn and tilt or a tilt before turn mechanism. These operating instructions are described in the previous chapters.

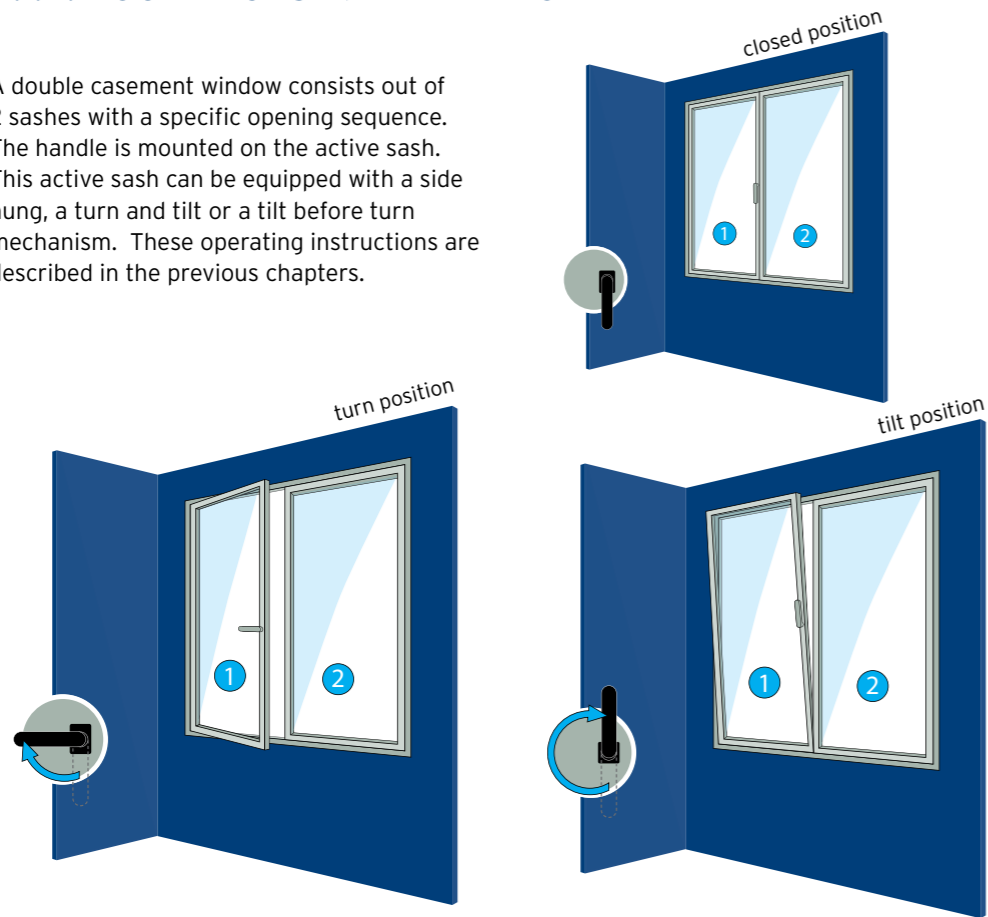

In order to open the inactive (or casement) sash, the active sash needs to be opened inwards completely. The inactive sash is equipped with locking bolts or a central locking mechanism. By unlocking these bolts or central locking mechanism, the inactive sash can be opened in side-hung position. To close the window, simply reverse the order.

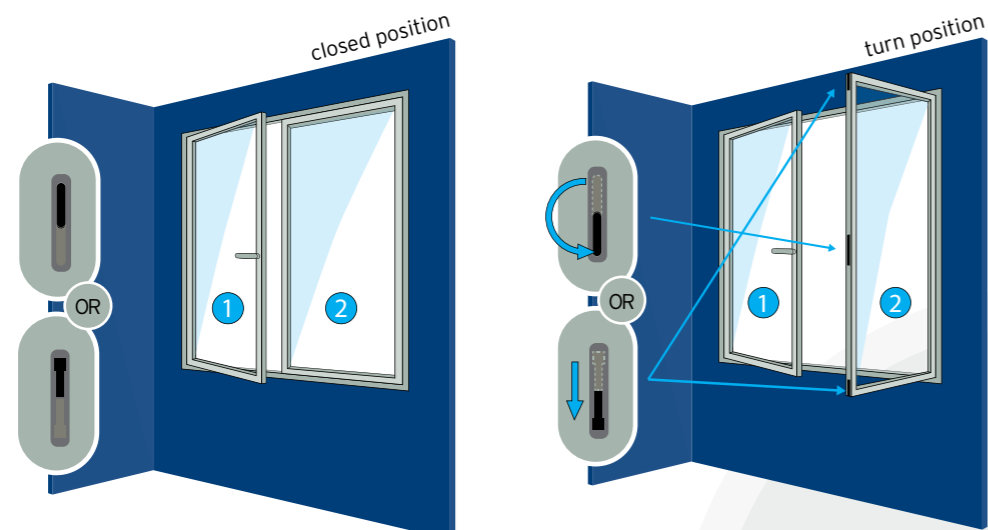

1 active sash 2 inactive sash



## 2.1.5. BOTTOM HUNG WINDOW OPENING INWARD

This element is equipped with either a handle, lever, spring latch or an automated opening mechanism. By operating the handle or spring latch, the window sash will move to a tilt position.

As a basic principle, bottom hung sashes are secured in the tilt position, to avoid uncontrolled slamming open, by means of stay-arms (tilt safety cleaning stay-arms). These stays can be detached for maintenance of the windows.

### VERTICAL / HORIZONTAL HANDLE

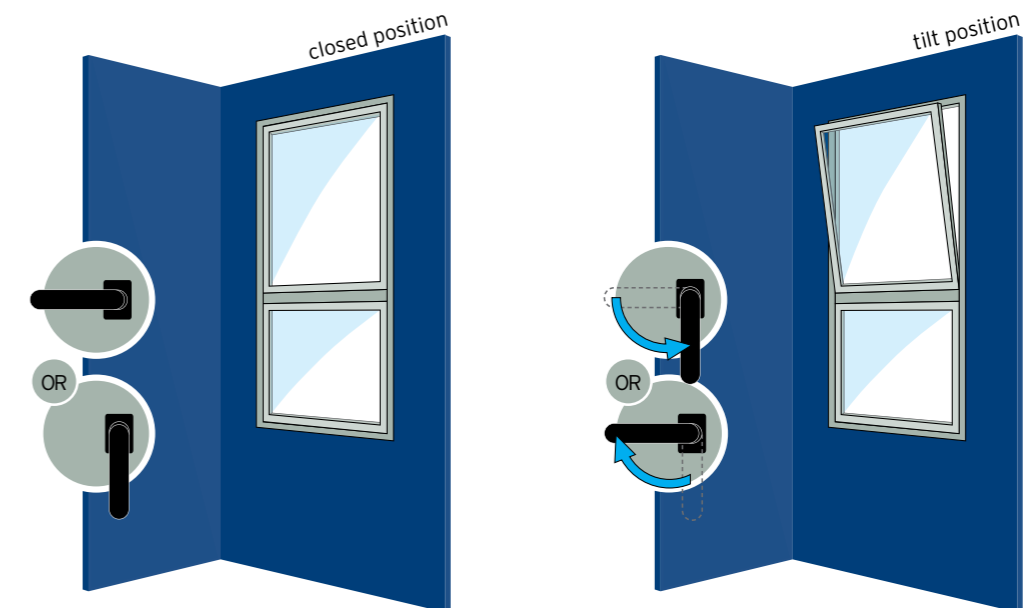

### FANLIGHT ACCESSOIRES





### 2.1.6. SIDE HUNG WINDOW OPENING OUTWARD

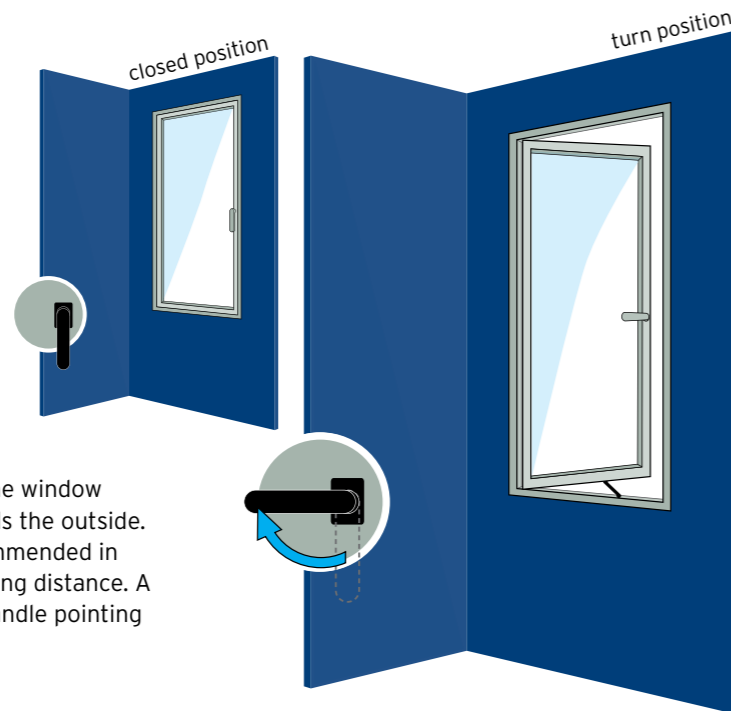

By operating the handle, the window sash can be opened towards the outside. An opening limiter is recommended in order to regulate the opening distance. A handle position with the handle pointing upwards is not possible.



### 2.1.8. TOP HUNG OUTWARD PROJECTING WINDOW



By operating the handle, the window sash is projected towards the outside, with limited opening angles. A position with the handle pointing downwards is not possible.

### 2.1.7. TOP HUNG WINDOW OPENING OUTWARD

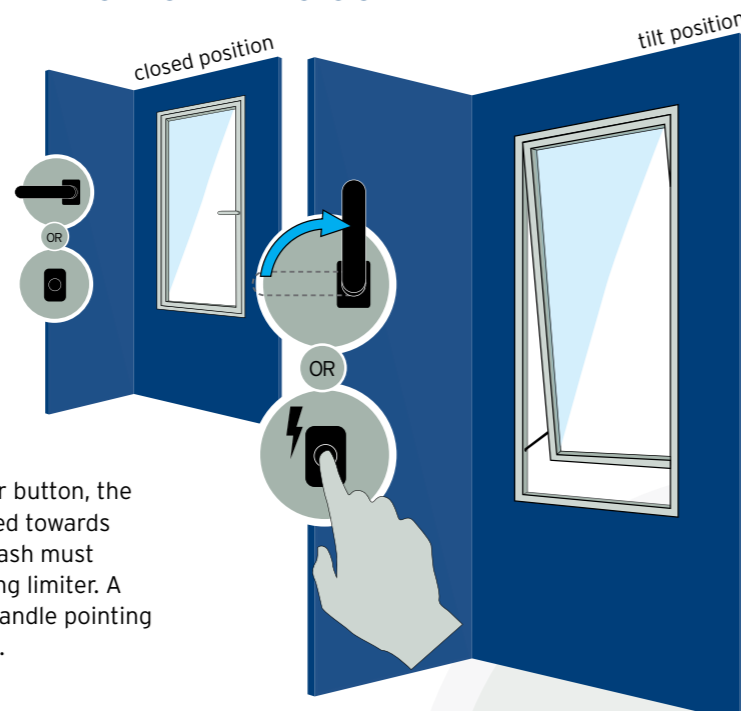

By operating the handle or button, the window sash can be opened towards the outside. The opened sash must be arrested with an opening limiter. A handle position with the handle pointing downwards is not possible.

### 2.1.9. PARALLEL OUTWARD OPENING WINDOW

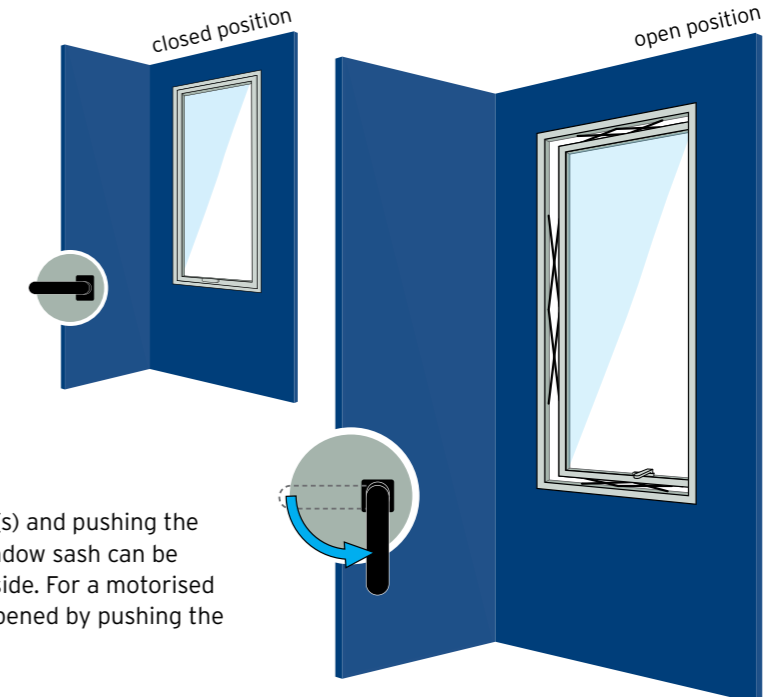

By operating the handle(s) and pushing the window outward, the window sash can be opened towards the outside. For a motorised version, the window is opened by pushing the button.





### 2.1.10. VERTICAL PIVOTING WINDOW



By operating the handle, the window sash will pivot around the vertical central axis. A position with the handle pointing upwards is not possible.

### 2.1.11. HORIZONTAL PIVOTING WINDOW

By operating the handle, the window sash will pivot around the horizontal central axis. A position with the handle pointing downwards is not possible.

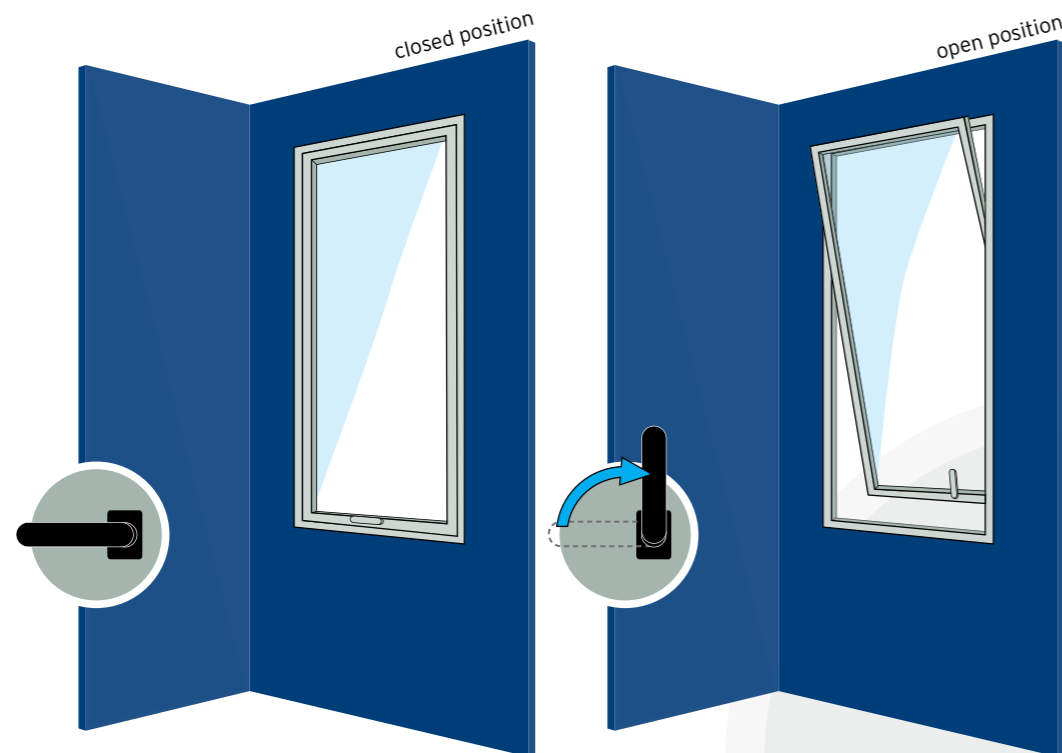

### 2.1.12. SLIDING WINDOW

There are 3 types of opening mechanisms:

1. **Handle operated:** in order to open the sliding element, turn the handle to a horizontal position (quarter turn) and slide the window open. To close the element, simply reverse the order.
2. Sliding elements with a **fixed handle** are locked and unlocked by turning the cylinder.
3. **Integrated handle:** the sliding window is unlocked by sliding up the mechanism inside the handle. You will have a visual feedback of a green colour when the door is unlocked. To lock the window, simply reverse the order and a red colour will be visible.





### 2.1.13. FOLDING WINDOW

To open the folding element completely, open the first sash by turning the handle to the open position.

The first sash must be positioned 90° to the rail and consequently, you can open the second handle. Once the second handle is open, you can open the second sash by pulling (inward opening) or pushing (outward opening) the secondary handle, and also position it in a 90° angle.

To close the folding window, push the secondary handle (inward opening) or pull the secondary handle together with the auxiliary handle on the hinge (outward opening) until the sashes are positioned on top of the rail. Close the window by putting the handle in downward position. The primary sash can be closed consequently.

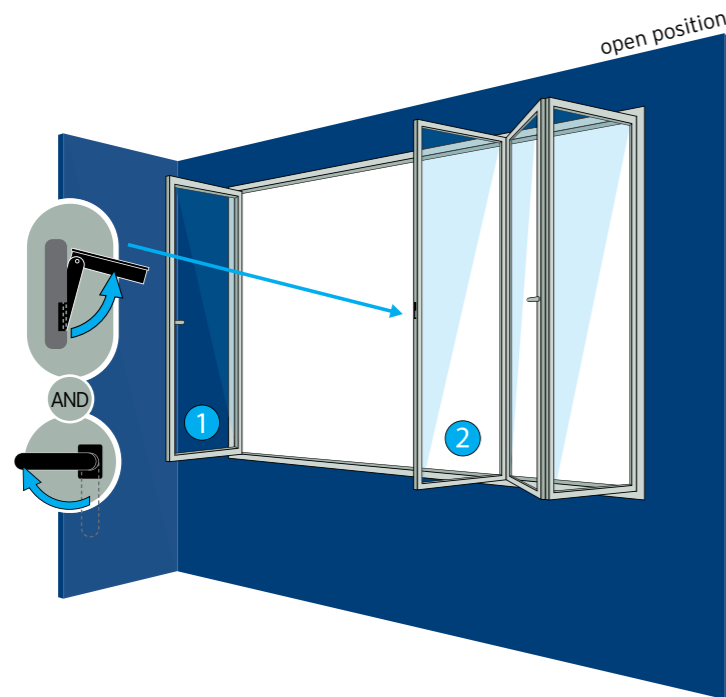
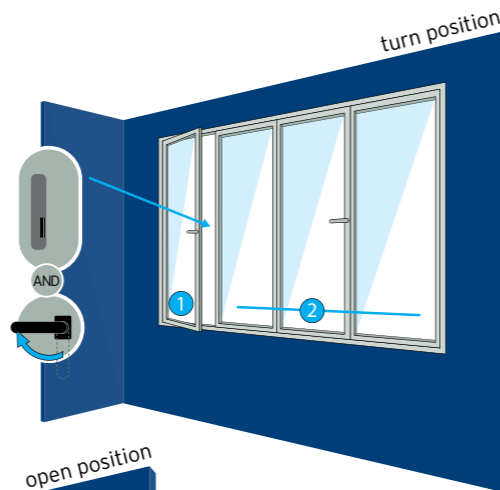
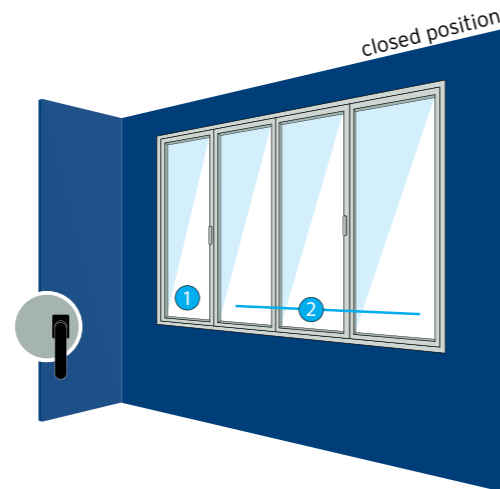

1 active sash 2 inactive sash



### 2.1.14. ROOF WINDOW

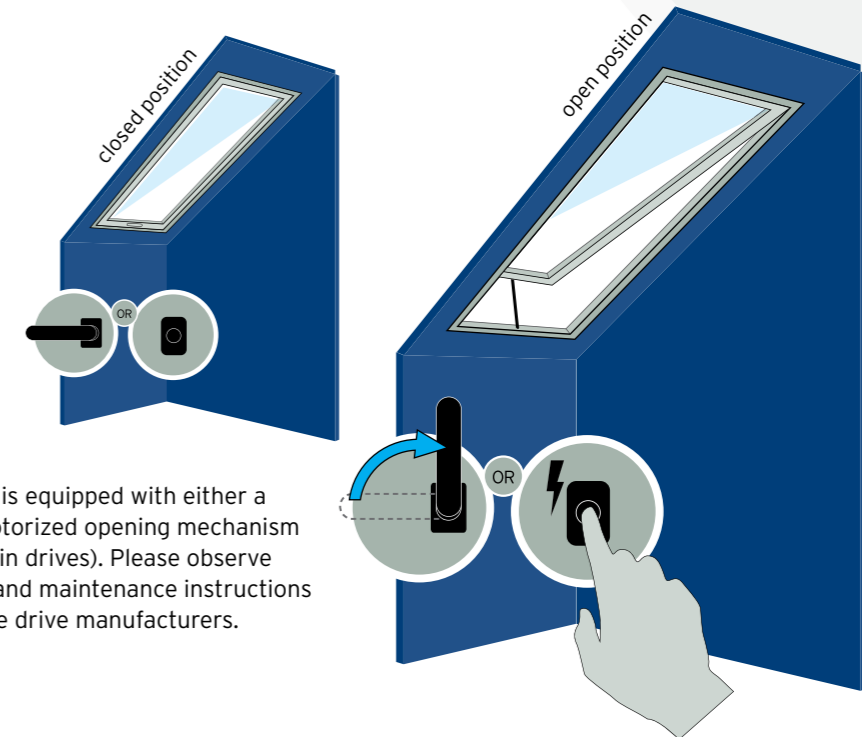

A roof window is equipped with either a handle or a motorized opening mechanism (spindle or chain drives). Please observe the operating and maintenance instructions provided by the drive manufacturers.

### 2.1.15. VENTALIS

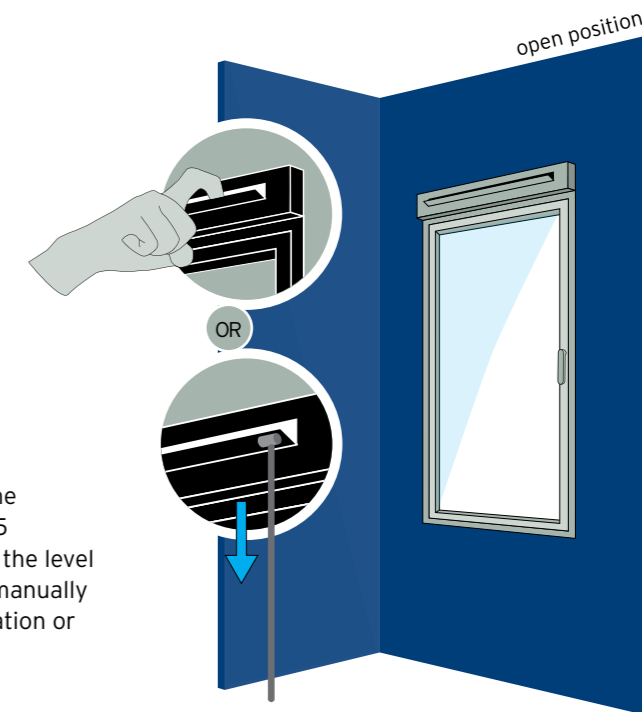

The Ventalis system can regulate the ventilation of a room. Ventalis has 5 opening positions which determine the level of airflow. The flap can be opened manually or with an operation rod, for ventilation or maintenance purposes.



## 2.2. ACCESSORIES FOR WINDOWS

### 2.2.1. WINDOW HANDLES

#### TURN BEFORE TILT

Turn the window handle by 90° to achieve a turn position. By turning the handle 180°, a tilt position is obtained. If the handle is equipped with a cylinder lock, make sure this is unlocked as indicated on the drawing before operating the handle.

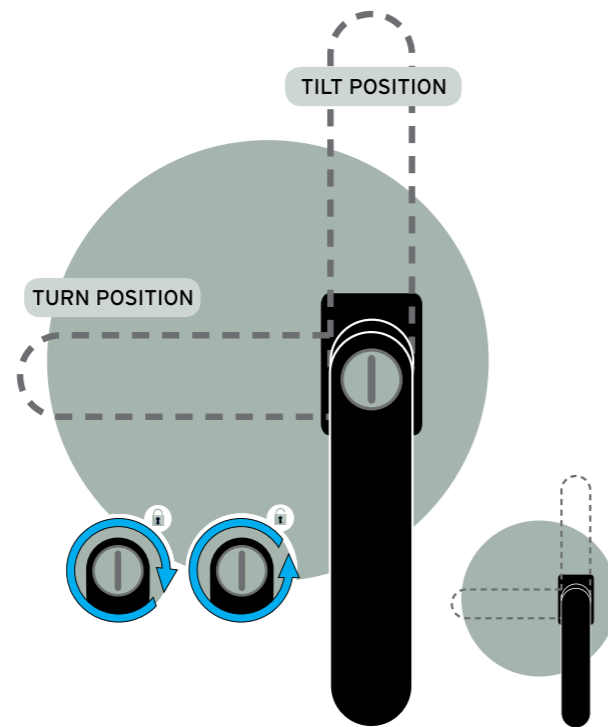

#### TILT BEFORE TURN

Turn the window handle by 90° to achieve a tilt position. By turning the handle 180°, a turn position is obtained. If the handle is equipped with a cylinder lock, make sure this is unlocked as indicated on the drawing before operating the handle.

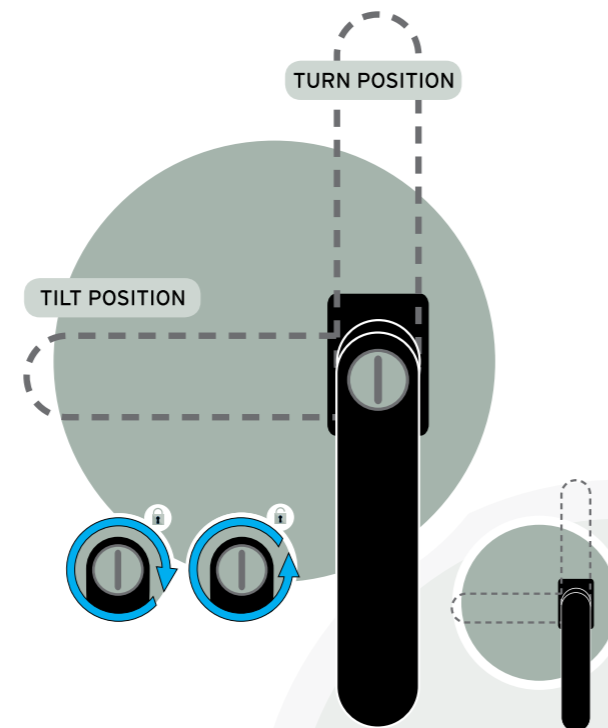

#### SPRING LATCH

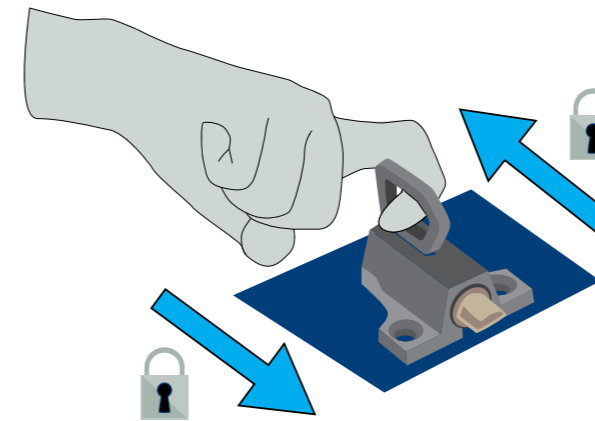

#### INTEGRATED HANDLE

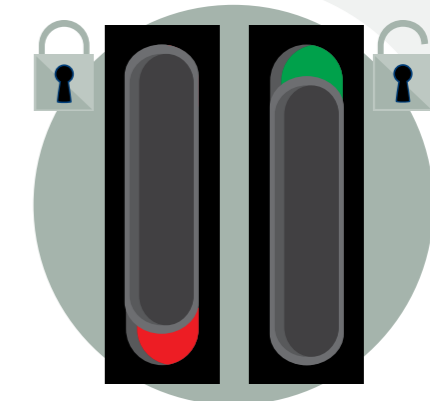

You will have a visual feedback of a green colour when the door is unlocked. To lock the window, simply reverse the order and a red colour will be visible.

### 2.2.2. OPENING LIMITER

An opening limiter can be used to determine the opening distance of an inward or outward opening turn window up to 90°. It is possible to unlock the opening limiter to open the window for cleaning or maintenance purposes.



**WARNING!**  
For outward opening windows we recommend to limit the opening to 100 mm.

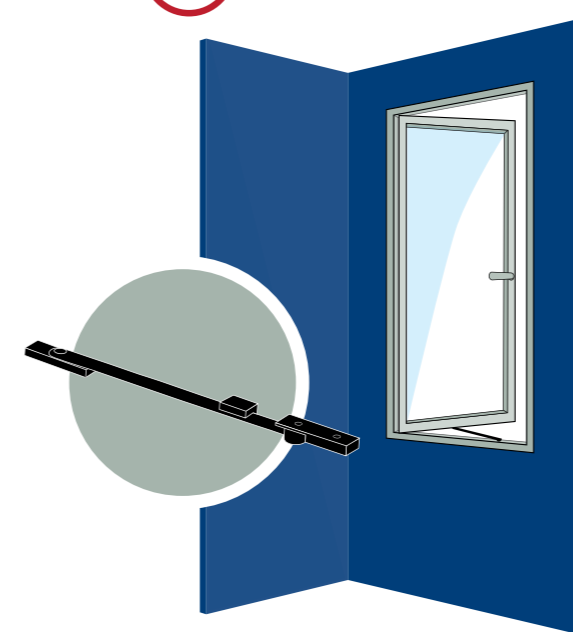



### 2.2.3. VENTILATION SLID

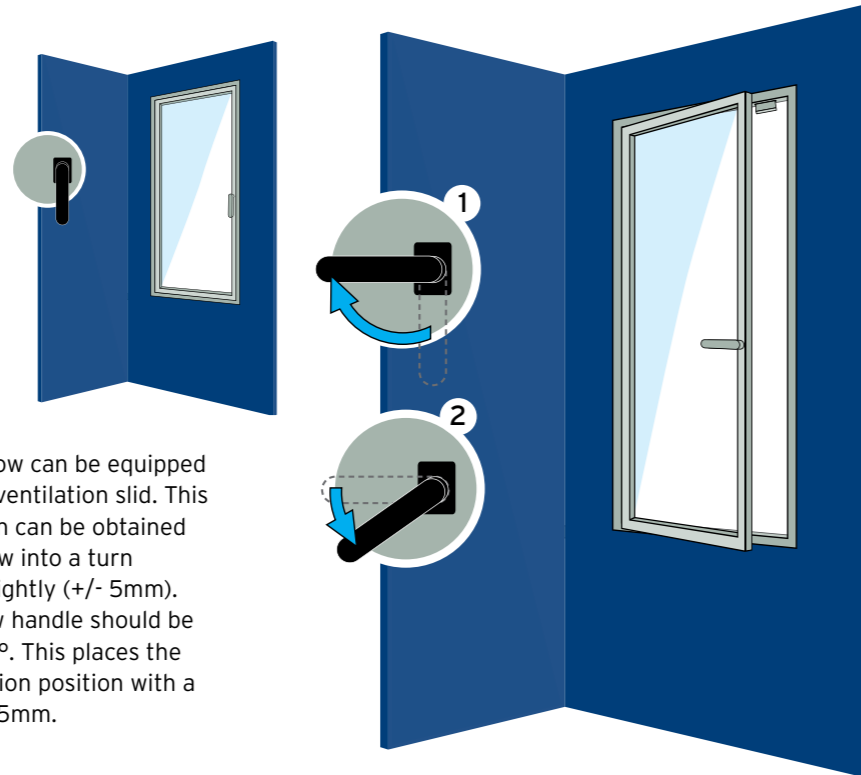

The inward opening window can be equipped with a device to create a ventilation slid. This small space for ventilation can be obtained by first putting the window into a turn position and opening it slightly (+/- 5mm). Subsequently, the window handle should be pushed downwards by 45°. This places the window in a fixed ventilation position with a slight opening gap of +/- 5mm.

### 2.2.4. BALCONY DOOR SNAPPER

A balcony door snapper makes it possible to keep a balcony door closed without the need to operate any locking mechanism. It is activated by simply closing the door behind you when entering the balcony. To unlock it, simply push the fixed handle on the outside and the door is opened again. Operate the lock on the inside to activate the secure locking mechanism, keeping unwanted visitors from entering your home.

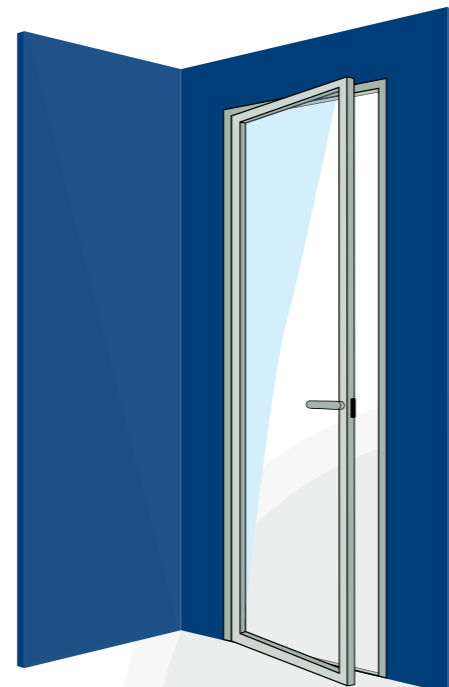

### 2.2.5. BUILT ON LOCK

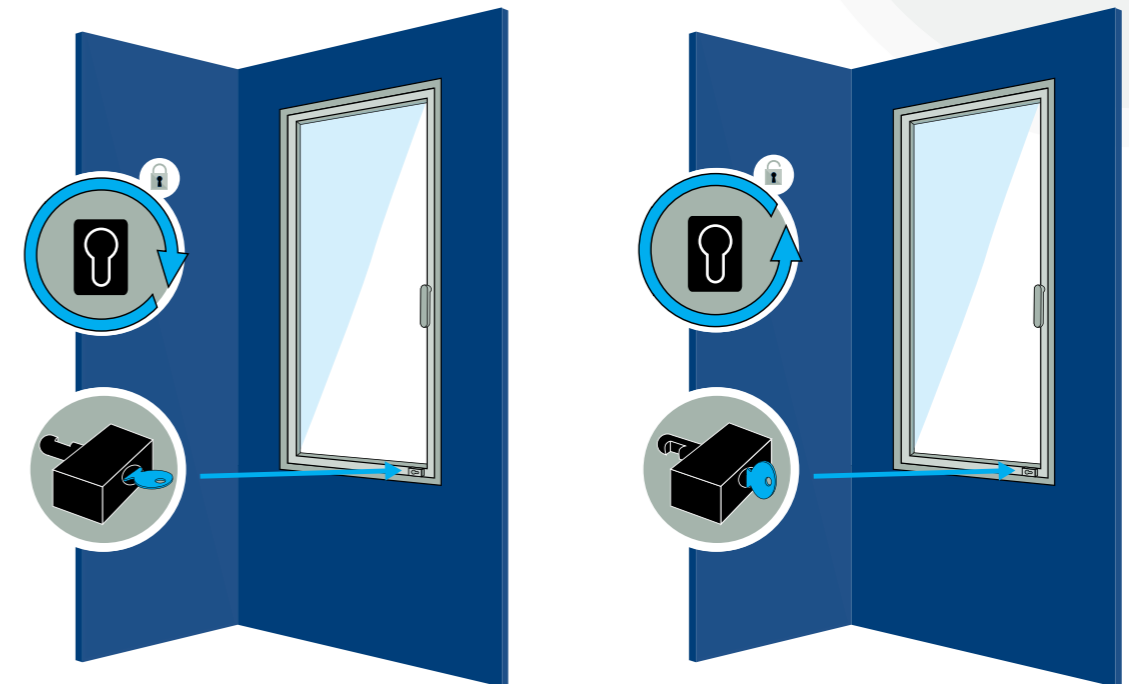

The built on lock serves as a locking of the turning position in turn and turn-tilt windows. With turn-tilt sashes, the tilt position can also be activated when the built on lock is activated.

#### LOCKED POSITION

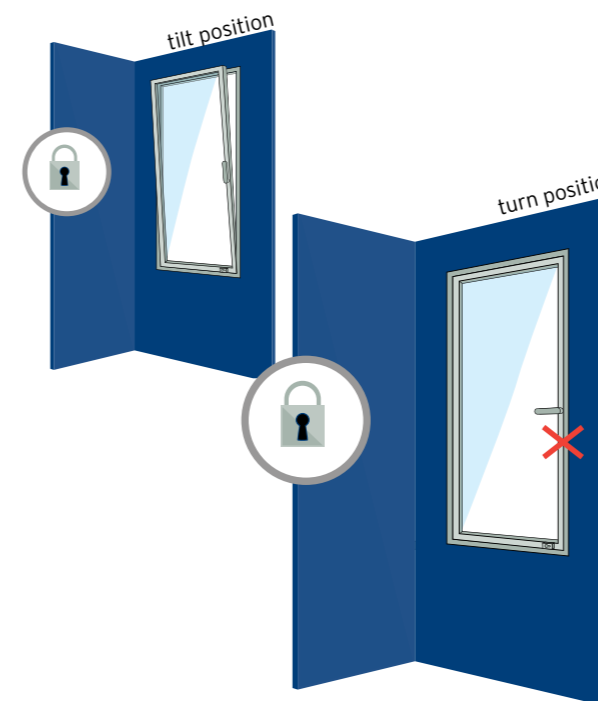

#### UNLOCKED POSITION



## 3. OPERATION OF DOORS

### 3.1. OPENING TYPES

#### 3.1.1. SINGLE DOORS

To open a single door, push the handle downwards while pulling (inward opening) or pushing (outward opening) the door. To close the door, leave the handle in its original horizontal position and simply push or pull until the door is closed.

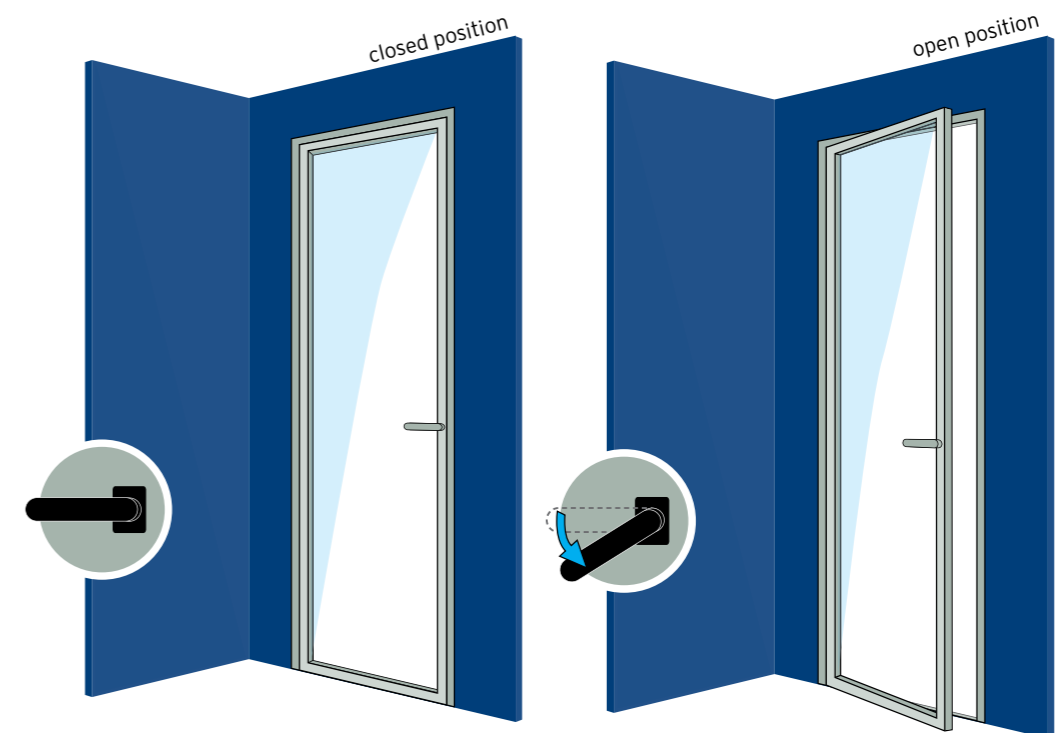



### 3.1.2. DOUBLE DOORS

A double door consists out of two sections with a specific opening sequence. The door is equipped with a handle and the casement is equipped with locking bolts or central locking.

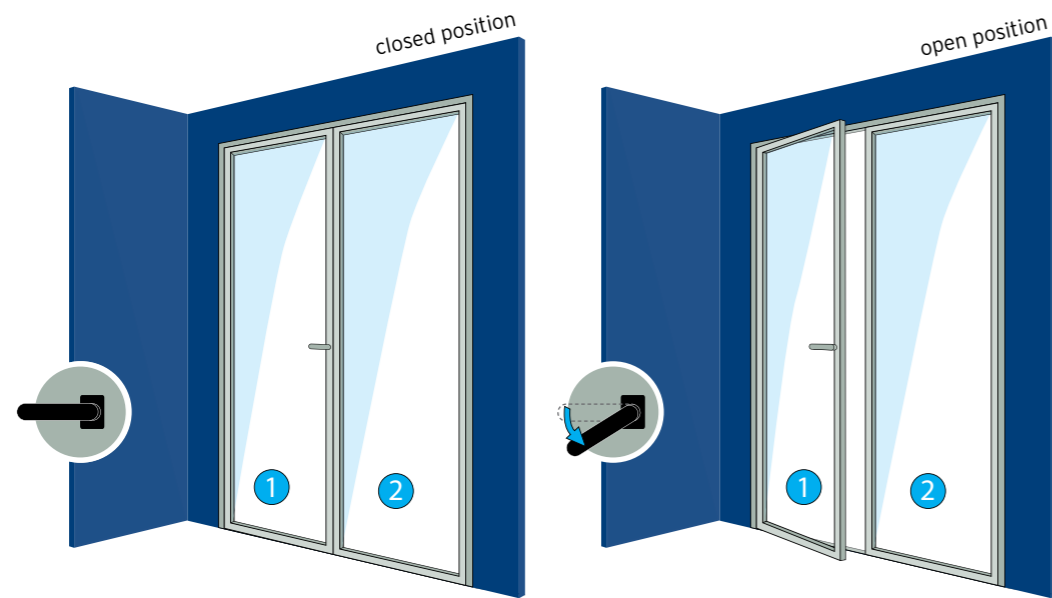

In order to open the second door, open the first door as indicated in the previous chapters. Subsequently, the locking bolts need to be unlocked before opening the second door. To close the doors, simply reverse the order.



1 active sash 2 inactive sash



### 3.1.3. PIVOTING DOORS

This element is equipped with either a normal or a fixed handle. By operating the handle, the door sash will pivot around the vertical central axis.

**Fixed handle:** grab the handle and simply push or pull the door.

**Handle-operated:** to open the element, push the handle downwards while pulling or pushing the door.

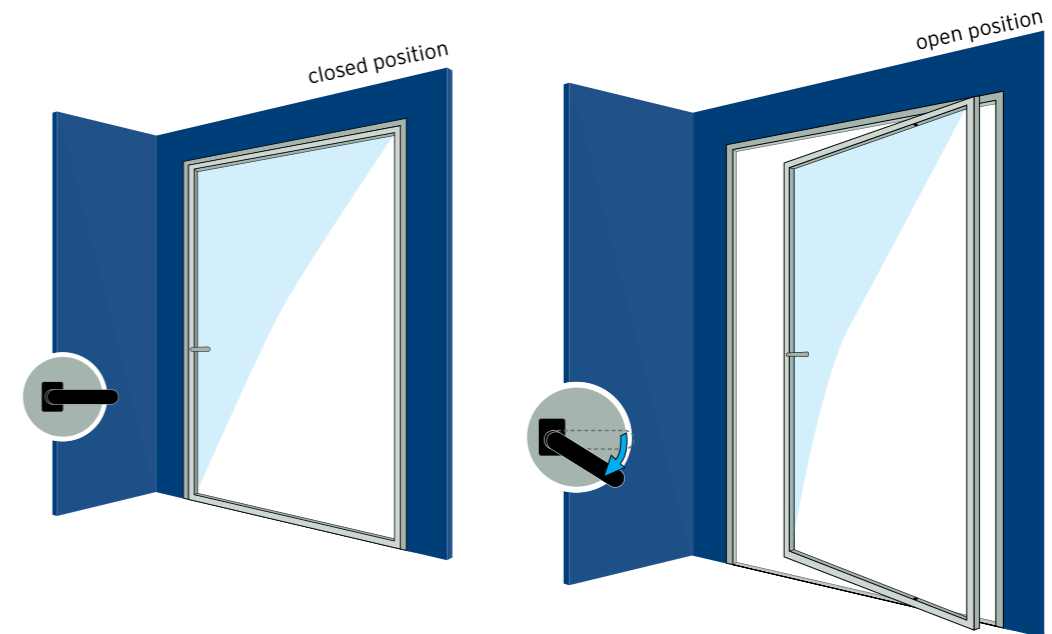

#### Locking

There are three options for locking a Pivot Door:

**1. Single lock**

The door operates as any other door.

**2. Double lock manual**

To open the door, unlock both cylinder locks by turning the key until the end. While unlocked, the pivoting door can be opened and closed as any other door.

**3. Double automatic lock**

Both locks are electrically synchronized and the door operates as any other door.

**WARNING!**



In case of power failure the door will remain closed. Therefore this door should not be the only access/exit to the building. To continue operating the lock or motor in case of power failure, an optional battery pack can be installed.

If the automatic lock is also provided with cylinder locks, it is still possible to open the door manually. This requires that both locks are operated at the same time (for wide doors this may require two people.)

#### Opening limiter

A MasterLine 8 Pivot Door should always be equipped with an opening limiter to avoid damage when being opened past its maximum opening angle.



**WARNING!**

Do not use large pivoting doors with gusts of wind or risk of draft due to risk of damage.

### 3.1.4. SLIDING DOORS

There are 3 types of opening mechanisms:

1. **Handle operated:** in order to open the sliding element, turn the handle to a horizontal position (quarter turn) and slide the window open. To close the element, simply reverse the order.
2. Sliding elements with a **fixed handle** are locked and unlocked by turning the cylinder.
3. **Integrated handle:** the sliding door is unlocked by sliding up the mechanism inside the handle. You will have a visual feedback of a green sticker when the door is unlocked. To lock the door, simply reverse the order and a red sticker will be visible.

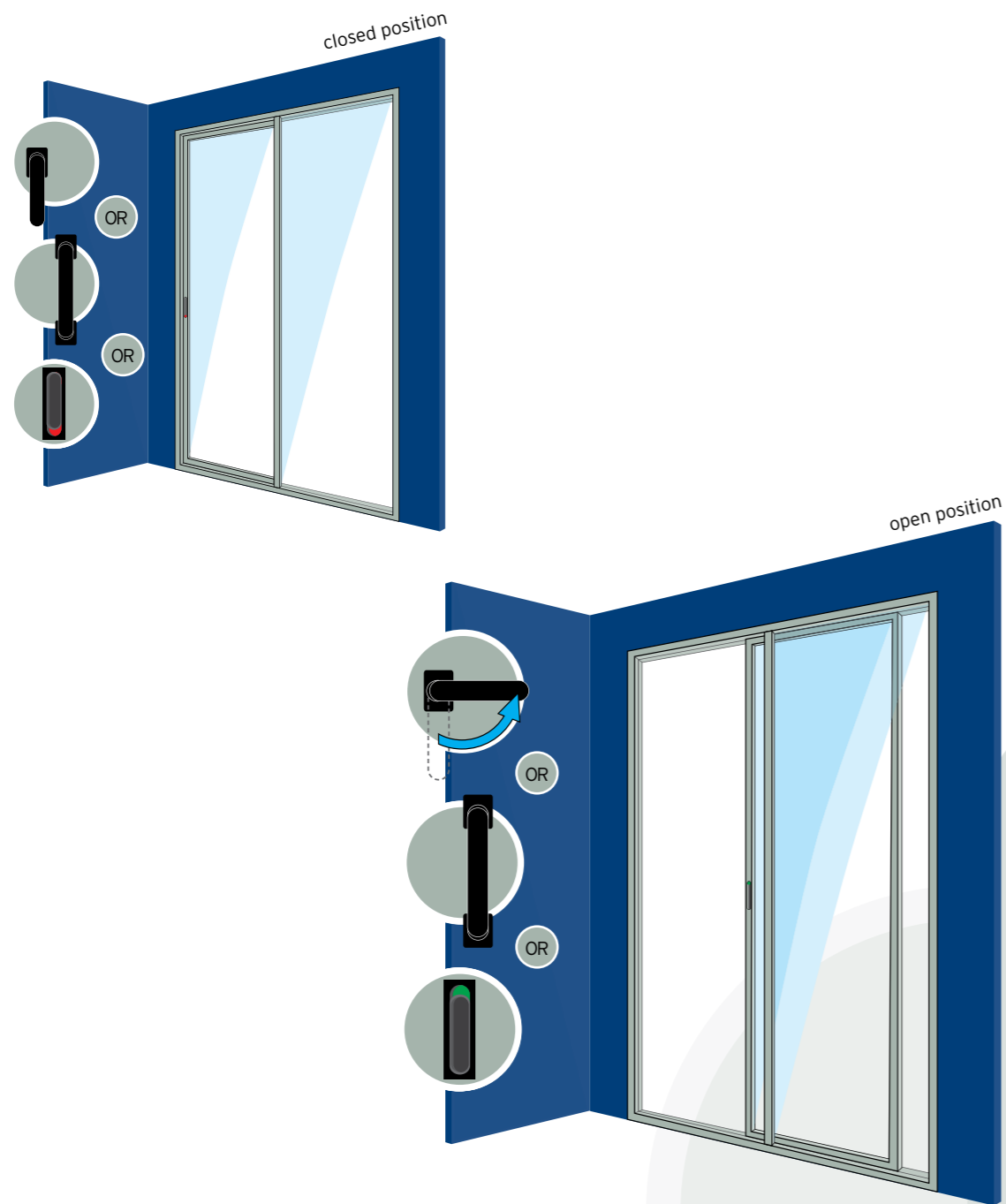

### 3.1.5. HI-FINITY SLIDING DOOR

In order to open the element, push the button to unlock the element and slide the window open. A visible LED feedback indicates the lock is open. To close the element, simply reverse the order: slide the window to the closed position, and push the button again to activate the lock. For more information on the manual lock, please see separate manual for instructions.



**WARNING!**  
Hi-Finity should not be used as a primary door!

If power fails when the sliding element is open, you can still slide the element to the closed position, but the lock will not be activated. To continue operating the lock or motor in case of power failure, an optional battery pack can be installed.

Hi-Finity is also available in a motorised version: see dedicated user manual slide motor for instructions.



### 3.1.6. LIFT SLIDING DOORS

By turning the door handle 180° into the sliding position, the sash is raised by several millimeters. In order to close the sash, slide it into the closed position and lower it again by turning the handle 180° from the downward to the upward position. If the lift sliding door is equipped with a locking mechanism, unlock it before operating the handle.

It is possible to put the sliding system into a locked ventilation stand. Lower the sliding element +/- 12 mm before the closed position. This leaves a slight space for ventilation, while keeping unauthorized persons from entering.

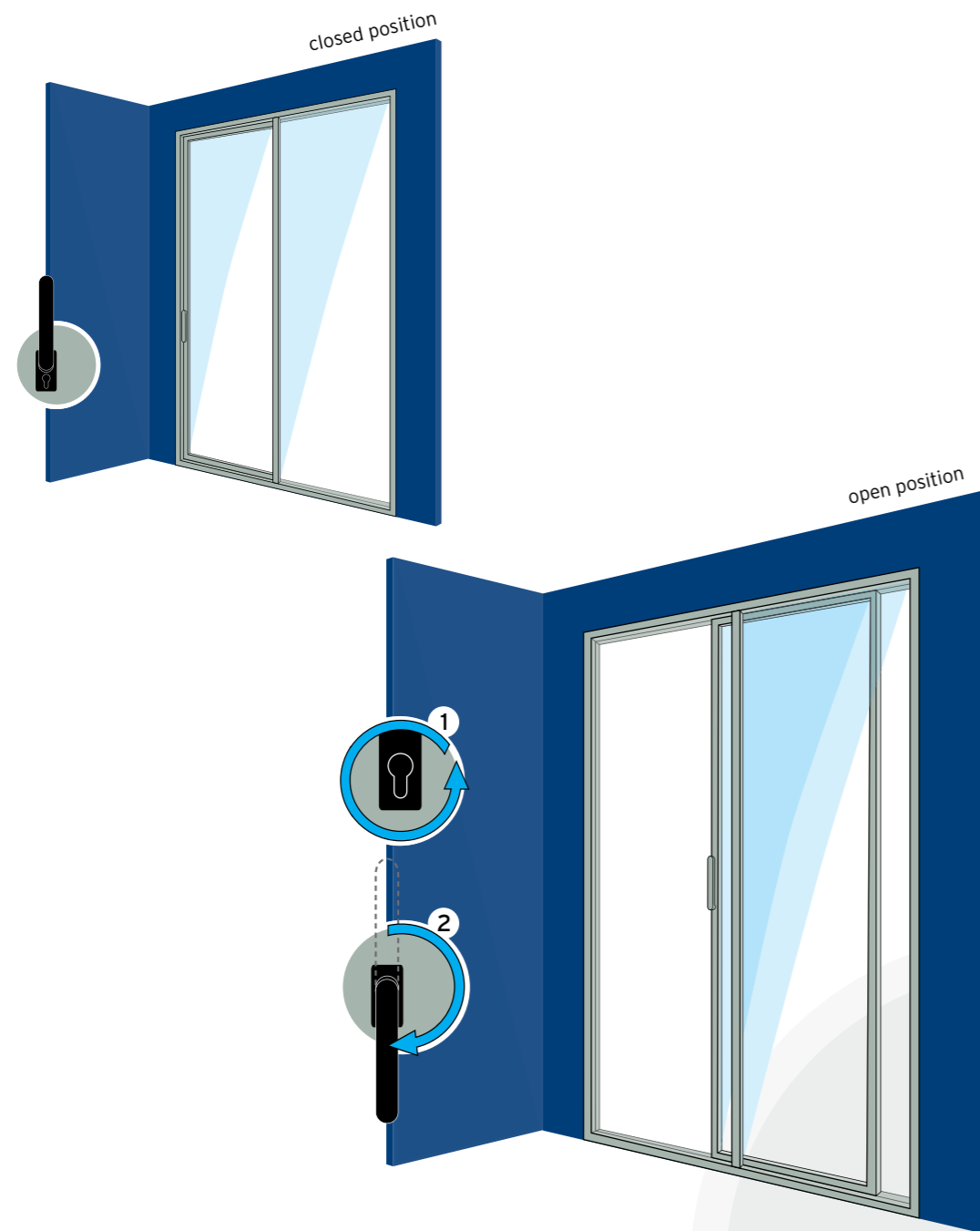



Please observe the safety remarks indicated on p. 5 - 7



### 3.1.7. FOLDING DOORS

If the folding element is fitted with a walk-in door, this part of the element can be operated like a normal door.

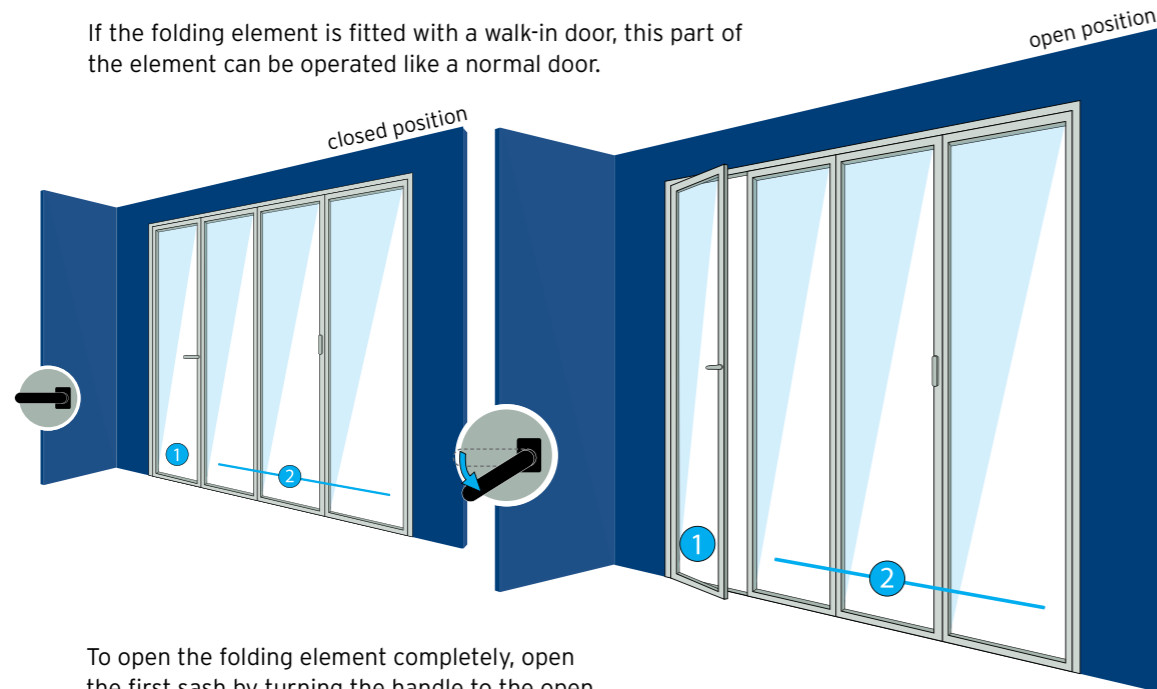

To open the folding element completely, open the first sash by turning the handle to the open position.

The first sash must be positioned 90° to the rail and consequently, you can open the second handle. Once the second handle is open, you can open the second sash by pulling (inward opening) or pushing (outward opening) the secondary handle, and also position it in a 90° angle.

To close the folding door, push the secondary handle (inward opening) or pull the secondary handle together with the auxiliary handle on the hinge (outward opening) until the sashes are positioned on top of the rail. Close the door by putting the handle in downward position. The primary sash can be closed consequently.

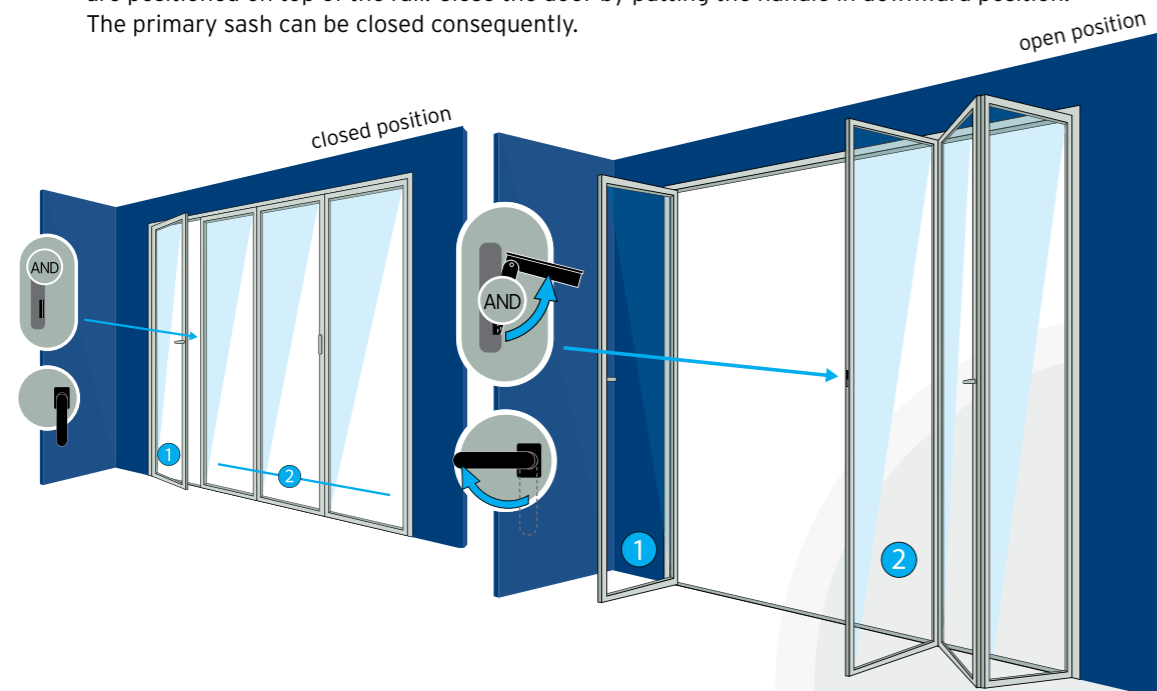

Please observe the safety remarks indicated on p. 5 - 7



### 3.1.8. THERMOFRONT

To access the tilt position for ventilation, turn the handle into a horizontal position before pulling the element. In order to obtain a complete opened window sash, turn the handle 135° into an upward position. Pull the sash in your direction so it comes loose from the casement, then slide it towards the opened position.

To close the element, slide the sash into the original position and apply pressure to the element. (First enclose the bottom section, then close the top sash and finally turn the handle to the closed position).

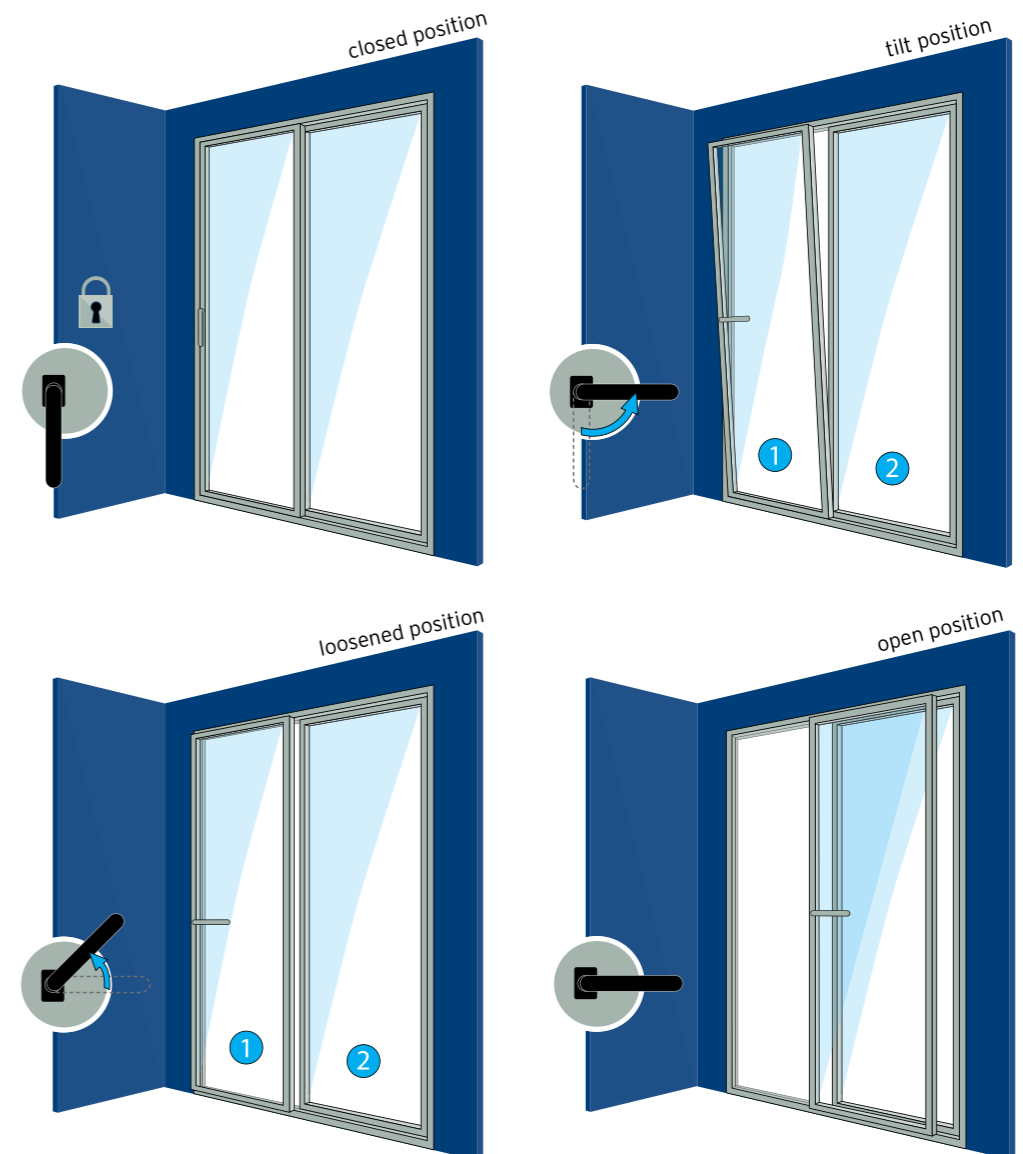

Please observe the safety remarks indicated on p. 5 - 7



Please observe the safety remarks indicated on p. 5 - 7



## 3.2. ACCESSORIES FOR DOORS

### 3.2.1. LOCKING AND UNLOCKING OF SINGLE DOORS

#### HANDLE OPERATED LOCK

When the door is in a closed position, move the handle upwards until you hear a click. This sound confirms that bolt and hook are in the locked position. To secure the lock, turn the key 1 turn clockwise.



#### CYLINDER OPERATED LOCK

When the door is in a closed position, turn the key 2 complete turns to lock and secure the door. To open the door turn the key 2 complete turns counter clockwise and push the handle to open the door.



#### AUTOMATIC MULTIPOINT LOCK

An automatic locking system allows the door to be locked without any manipulation by the user. When the door is put into a closed position, the locking system is activated automatically. To secure the door, turn the key 1 turn clockwise. To unlock the door, turn the key 1 turn counter clockwise and push the handle down.

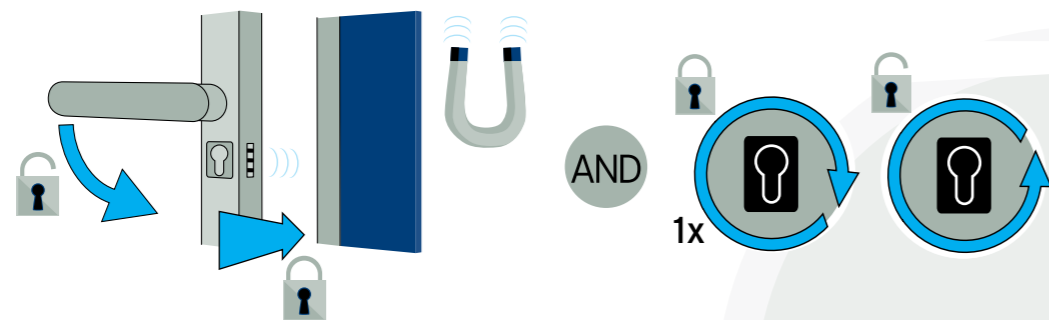

#### MOTOR OPERATED LOCK

The automatic locking mechanism is activated by pressing a button when the door is in a closed position. It can be unlocked in the same way.

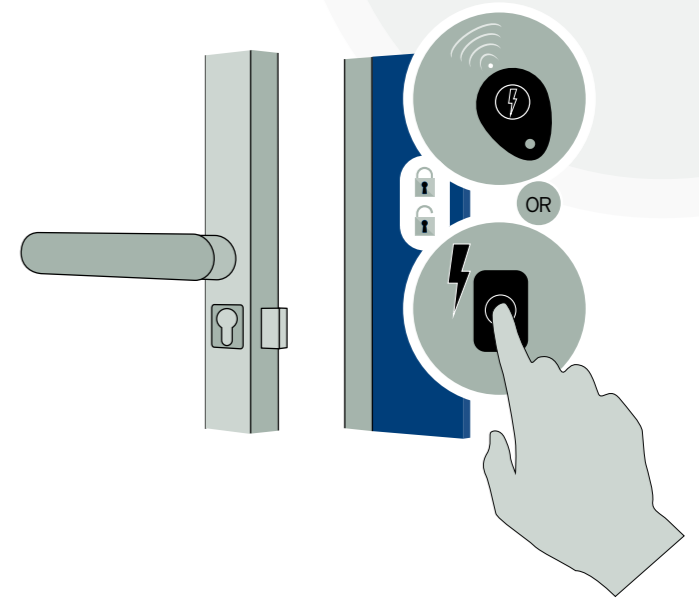

### 3.2.2. LOCKING AND UNLOCKING OF DOUBLE DOORS

First of all, the active door needs to be opened. Ways to open this first door are explained in previous chapters. In order to open the inactive door sash, the locking bolts on top and at the bottom of the door need to be manipulated as indicated on the drawing.

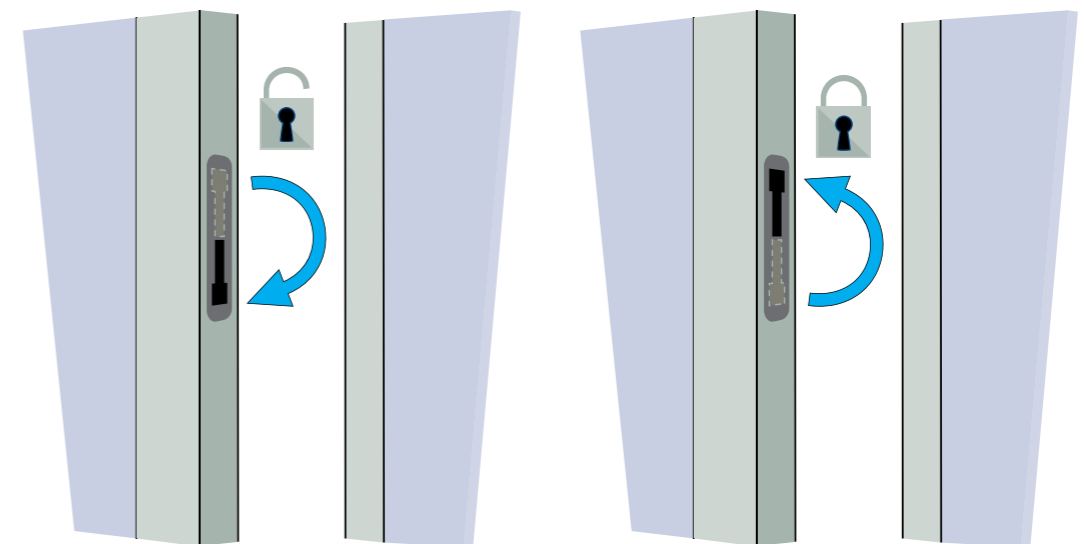

Please observe the safety remarks indicated on p. 5 - 7



Please observe the safety remarks indicated on p. 5 - 7



### 3.2.3. LOCKING AND UNLOCKING PANIC DOORS / ESCAPE DOORS

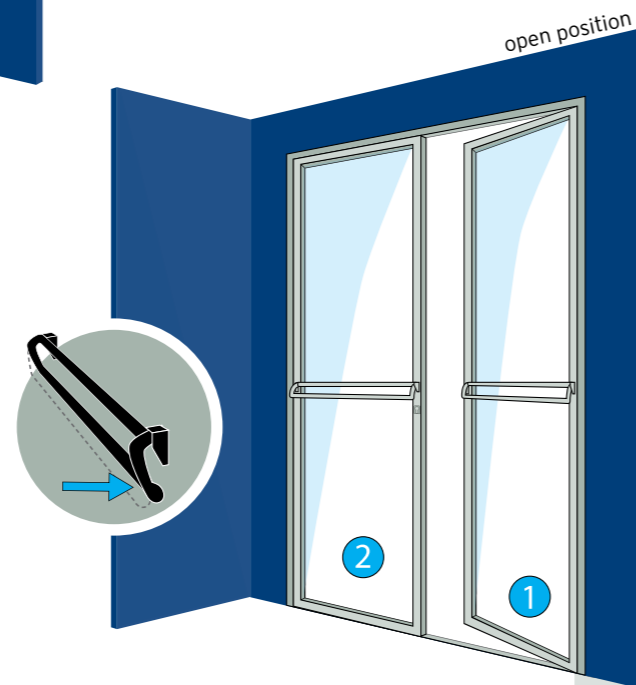

#### PANIC DOOR

To open panic doors, operate the handles as indicated on the drawings.

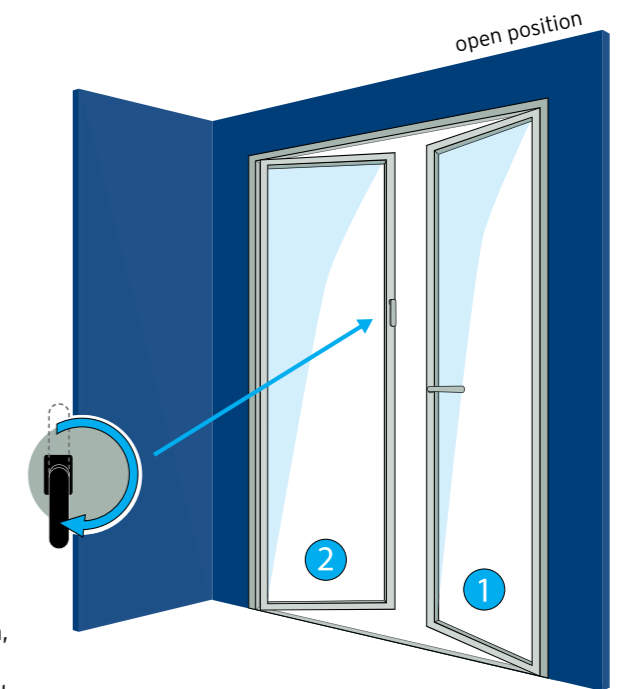
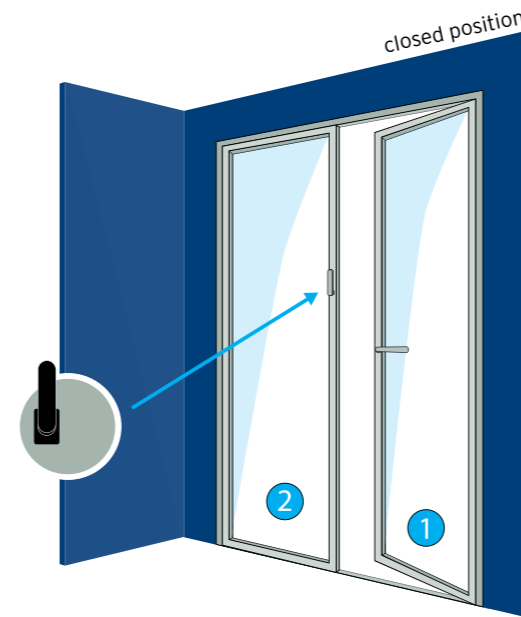

#### ESCAPE DOOR

The active sash is operated like a regular door. To open the inactive sash, the auxiliary handle should be turned by 180° from a downward to an upward pointing position.



**WARNING!** For detailed guidelines on specific opening possibilities and operations, we refer to the specific system catalogues of Reynaers Aluminium. If this is not available to you, a local Reynaers partner should be contacted.

Please observe the safety remarks indicated on p. 5 - 7



### 3.2.4. DOOR CLOSER

A door closer will automatically guide the door back to its closed position.



### 3.2.6. DOOR STOP

With a door stop, a door can be put in a fixed opened position.

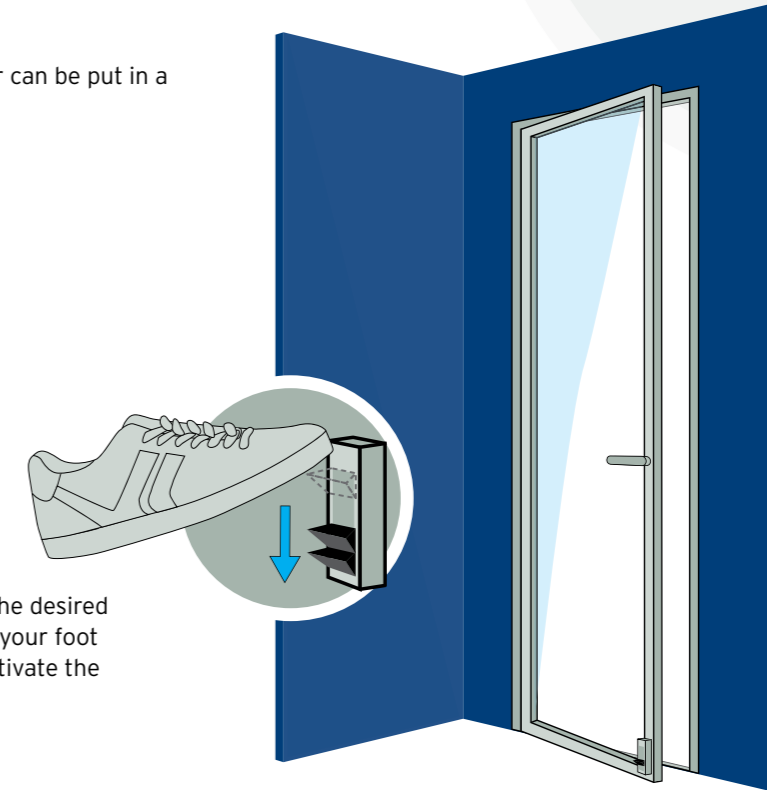

1. Open the door up to the desired opening distance. Push your foot down on the lever to activate the stop-function.

### 3.2.5. RESTRICTOR LOCK

The opening distance of a door can be limited for safety reasons by means of a restrictor lock. Operate the rotary knob to activate the locking mechanism and to allow for maximum 15cm of door opening. This safety measure will keep unauthorized persons from opening the door.

To open the door completely and to deactivate the restrictor lock, first close the door again. Subsequently, turn the rotary knob in the opposite 'open' direction. The door can now be opened normally.

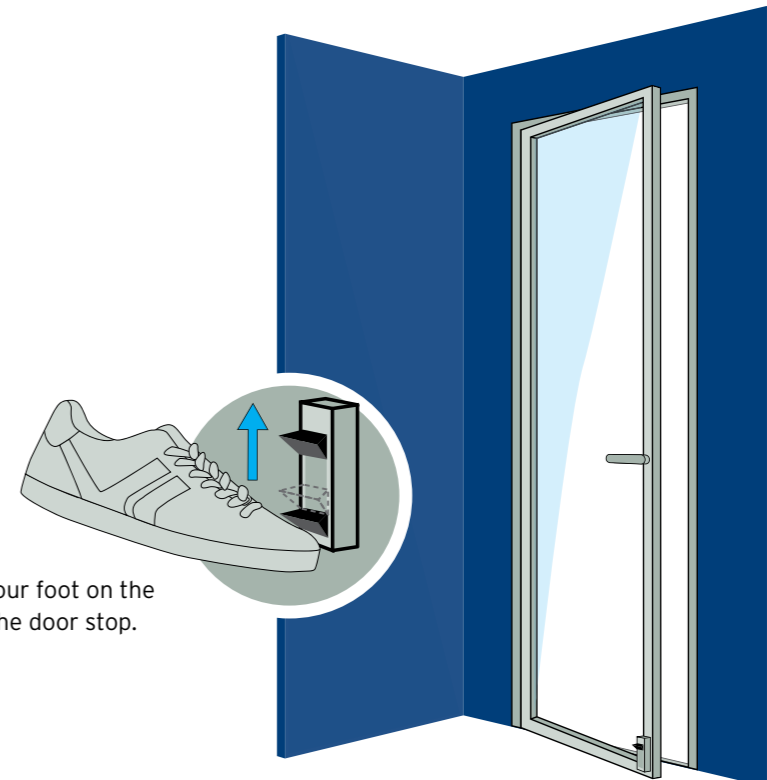
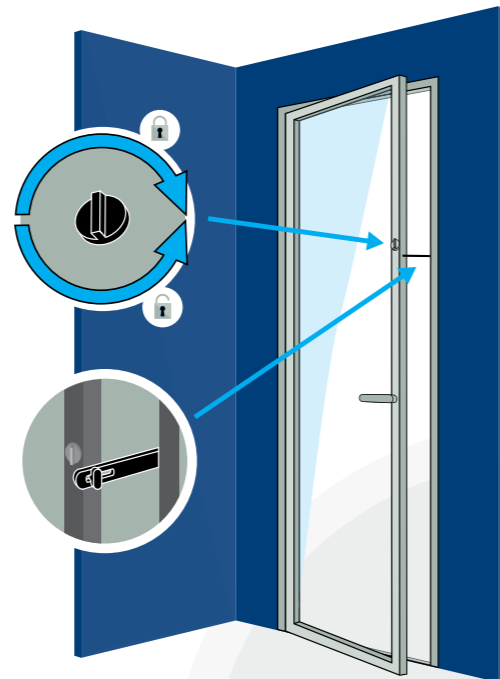

2. Release by tapping your foot on the lever at the bottom of the door stop.

## 4. CARE AND MAINTENANCE

### 4.1. GENERAL INSTRUCTIONS FOR CLEANING AND MAINTENANCE

Regular cleaning and maintenance of your window and door elements is of great importance to assure their correct functioning and their lifetime. The aluminium construction needs regular maintenance, using non-aggressive cleansing agents, like tepid water with a non-aggressive, pH-neutral (6-8), non-acetose detergent, not containing ammonia.

Reynaers windows are equipped with high qualitative hardware. This results in smooth and long lifetime operation of the system. To ensure a flawless operation of the window, maximal weights and dimensions, as prescribed in our catalogues, have to be respected.

Function and status of the hardware can be controlled based on following criteria:

#### OPERATION

The operation of the fittings can be checked on the handle. The force needed for locking and unlocking of the window is defined according to EN 12046. The operation ease can be increased by greasing or by adjusting the fittings.

#### FASTENING OF THE HARDWARE

The operation of the system is depending on the correct fastening of the fittings to the window/door element. The strength and position of the screws in the aluminium profile should be checked. In case screws are loose or damaged, they should be fixed or replaced.

#### THE BELOW MATERIALS CAN NOT BE USED TO CLEAN YOUR WINDOWS AND DOORS:

- Hard materials such as knives, steel wool, metal scrapers, sandpaper, etc. These will damage the surface of your window -and door elements.
- Aggressive or corrosive cleaning agents should be avoided as they can inflict irreversible damage to the surface treatment of your window -and door elements. Instead, use our dedicated range of Reynaers Care products. An overview of our care products can be found on page 48.

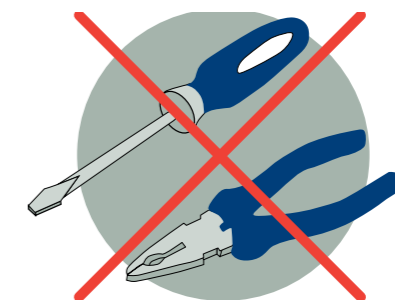
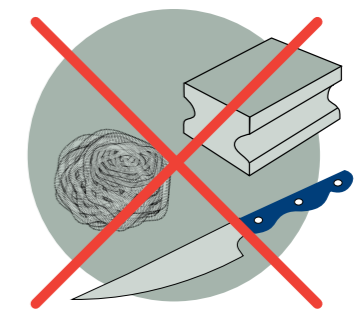
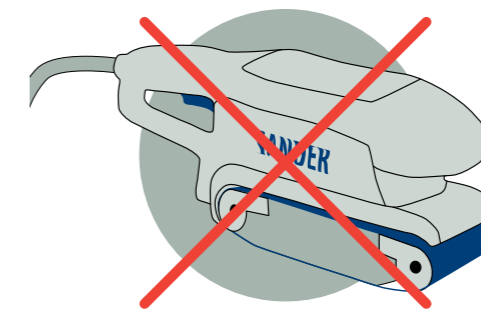

## 4.2. MAINTENANCE INTERVAL

Regular supervision of the elements is of major importance. The timeframe interval between these check-ups depends on the installation situation and the amount of window or door movements. This is defined in the contract with your fabricator.

Any possible irregularities in the operation (slowness, unusual sounds, ...) which might occur during maintenance must be reported immediately to the concerned specialist. Windows and sliding doors should undergo regular maintenance to prolong their service life and to ensure their functionality and the conservation of value.

OPENING TYPE	USE	FREQUENCY	MAX. CYCLES
Doors	Limited use	Once every 6 months	50.000 cycles
	Normal use		50.000 cycles
	Intensive use (Schools, Hospitals, public buildings,...)	Once every 3 months	50.000 cycles
	Panic doors (EN 179/EN1125)	Once every month	50.000 cycles
Windows/ Sliding systems		Once every 6 months	10.000 cycles

Frequency of maintenance for profiles and hardware in **non-corrosive atmospheres** and provided that the aluminium constructions are exposed to rain: twice a year. In all other cases: minimum 4 times a year.

Some **corrosive atmospheres** or other risk factors (e.g. limited rain) may however require even more frequent cleaning to be observed by the end-user.

Non-exhaustive list of examples of such corrosive atmospheres/risk factors:

- near the coast (<10km) or close to estuaria or large rivers (<5km);
- above water (condensation);
- within industrial areas, in particular areas with heavy emission of chemicals, fluorides, gasses, and ore materials;
- exposure to large traffic (motorways, railways, airports);
- very aggressive atmospheres (e.g. swimming pools, water treatment industry, laboratories, pollution by animals etc.)



**WARNING!** Special maintenance is required in case of fireproof doors. For detailed guidelines, we refer to the specific system catalogues of Reynaers Aluminium. If this is not available to you, a local Reynaers partner should be contacted.

## 4.3. OVERALL MAINTENANCE

### 4.3.1. MAINTENANCE OF DRAINAGE SLOTS

Clean the chamber between the moving and the fixed part every 6 months. If necessary, clear the drainage slots of any blockings.

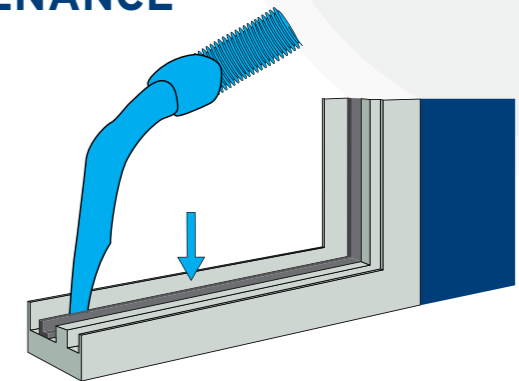

### 4.3.2. MAINTENANCE OF RAILS IN SLIDING AND LIFT- AND SLIDE ELEMENTS

Dirt and sand might collect in the bottom profile of your sliding/folding door. Clean the gutter(s) every month. If necessary, clear the drainage holes of any blockings. Remove the dirt, dust, grease and graphite annually from the rail with a cloth.

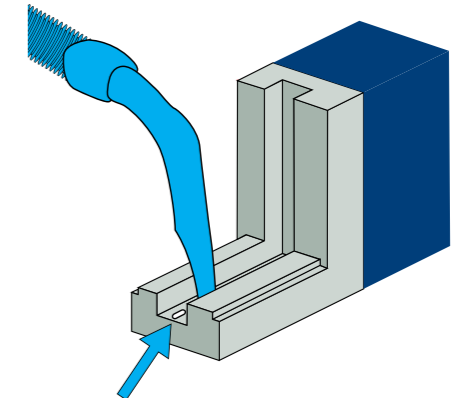

### 4.3.3. MAINTENANCE OF GASKETS

Once a year, apply normal domestic talc to the gaskets (in EPDM) between the moving and the fixed part of the element, or apply liquid silicone (by means of a cloth), to avoid cracks and deposits.

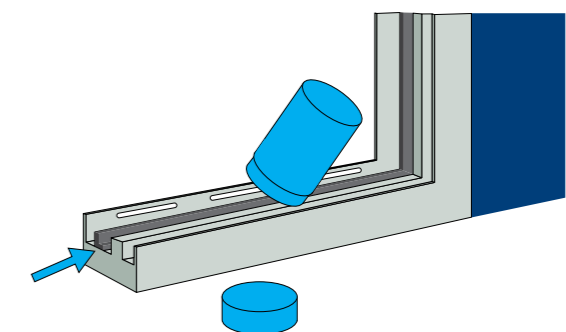

#### 4.3.4. MAINTENANCE OF HARDWARE AND ACCESSORIES

Remove the dust, grease and graphite annually\* from the following areas. Clean hardware exclusively with a soft cloth and mild, pH-neutral cleaning materials in diluted form.

- Window gearing
- Friction hinges
- Moving parts of the handles
- Locks and cylinders, using a graphite pipette and graphite powder
- The opening restrictor of the sliding element

\* The frequency depends on opening type and environment, please check specifications in chapter 4.2



#### WARNING!

- **Avoid silicon lubricants**, rather use a dry cloth and fitting oil to protect the surface and prevent dust collection on the hardware parts.
- **Do not lubricate** the composite rods or door hinges.
- Never use aggressive acidiferous cleaning materials or scouring agents. These can cause damage to the hardware.

#### 4.3.5. MAINTENANCE OF ELECTRICAL COMPONENTS

Check if the electrical lock and LED work properly and repeatedly: open and close the element several times to verify.

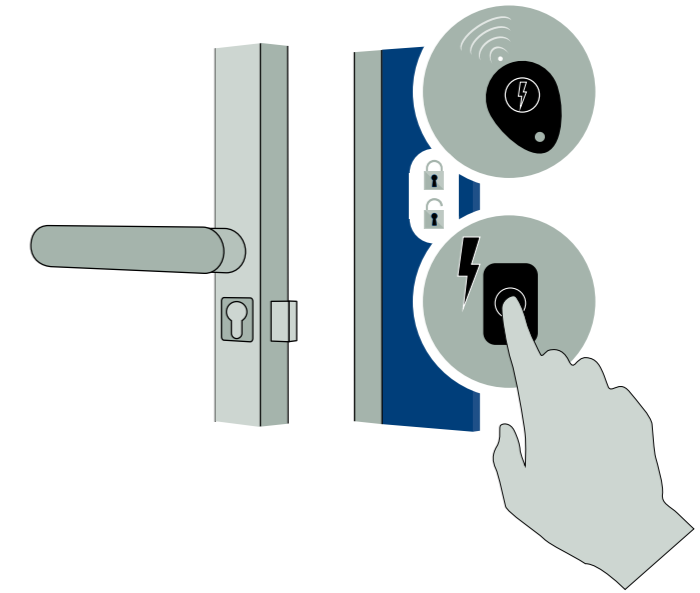

#### WARNING!

- Maintenance and repair of the motor and/or lock may only be carried out by qualified staff.
- Motorised sliding windows must never be used as escape routes. There must always be another way of leaving the room. Motorised sliding windows must not be used as fire doors.
- Make sure children do not play with the control button and/or cannot access the remote control.
- The motor must be able to be disconnected from the power supply for maintenance or repair work.
- Make sure water never enters the motor housing, even during cleaning.

## 4.4. CLEANING AND MAINTENANCE OF WINDOWS

### 4.4.1. TURN & TILT, TURN AND TILT & TURN

The following maintenance operations must be carried out on a regular basis:

1. Clean the mechanism and remove any traces of dirt. Use a soft cloth and mild, pH-neutral cleaning materials in diluted form.
2. Check all the components that are important for safety (hinges, extension arms). In particular, the hinges should be checked for damage and/or deformation due to violent impact.
3. Lubricate the moving parts and closure points as indicated in the diagram (use neutral lubricants). If necessary carry out adjustments to the mechanism and replace worn-out components to restore the correct functioning of the sash. This operation must be carried out by qualified service personnel.

If necessary carry out any adjustments of the mechanism and replace worn-out components to restore the correct functioning of the sash. This operation must be carried out by qualified service personnel.

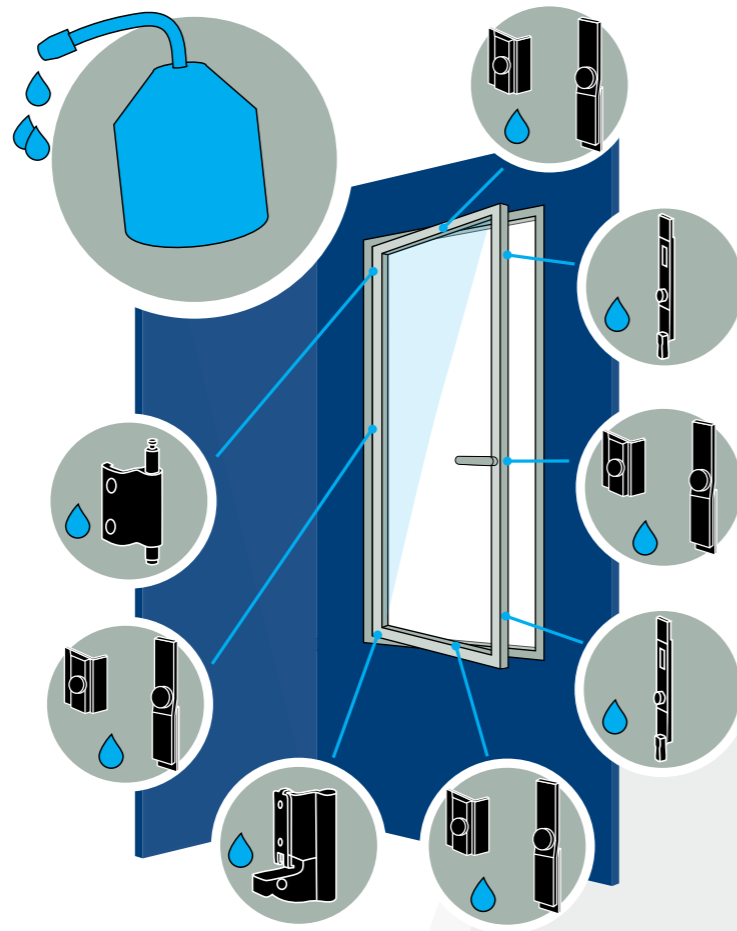

### 4.4.2. WINDOWS WITH FRICTION STAY

**Step 1:** clean all dirt, dust and debris from all parts of the product and keep any obstructions away from the pivoting and sliding parts.

1. Use a vacuum cleaner or a small soft brush to remove dry materials.
2. Use a dry cloth to remove any remains of dirt.

**Step 2:** check that all fixing screws are present and are securely and fully tightened.

**Step 3:** verify that other hardware fitted to the window assembly, e.g. hinges, locking mechanism(s), handles, motors, etc. are operating correctly.

**Step 4:** lubricate all pivoting and sliding parts of the products using high quality light, machine oil, such as provided in the Reynacare box.

1. One drop per pivot or sliding part is sufficient.
2. Do not use a WD40-type or silicone-based maintenance spray for lubrication purposes.

**Step 5:** wipe any excess lubricating oil over the surfaces of the hinge mechanism links using a soft lint free cloth.

**Step 6:** check the correct and smooth operation of the sash.

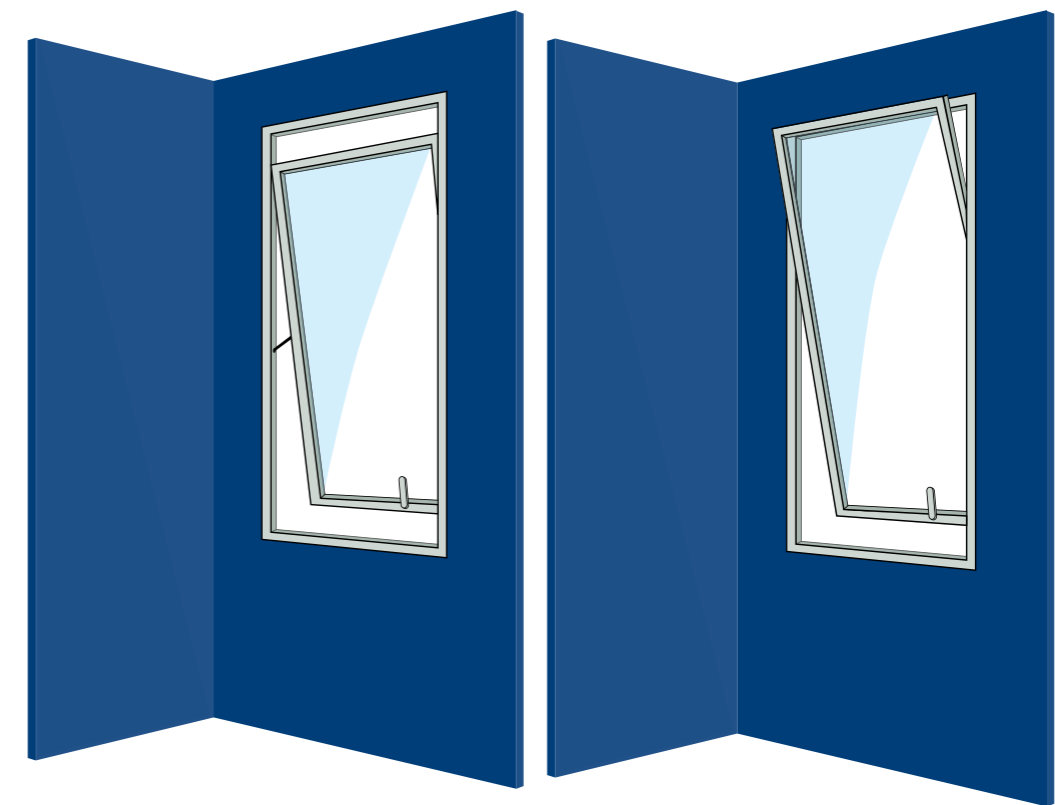



## 4.5. CLEANING AND MAINTENANCE OF DOORS

### 4.5.1. SINGLE & DOUBLE DOORS

#### DOOR LOCKS

Safety-relevant hardware should be checked at least annually\* for wear and tear and a continuous firm fit. Depending on the requirements, fixing screws have to be tightened. The damaged or worn parts should be exchanged by original parts by an authorized specialist.

All movable parts and locking parts have to be oiled and their working order should be checked. The cylinder can be maintained by using graphite powder.

\* The frequency depends on opening type and environment, please check specifications in chapter 4.2

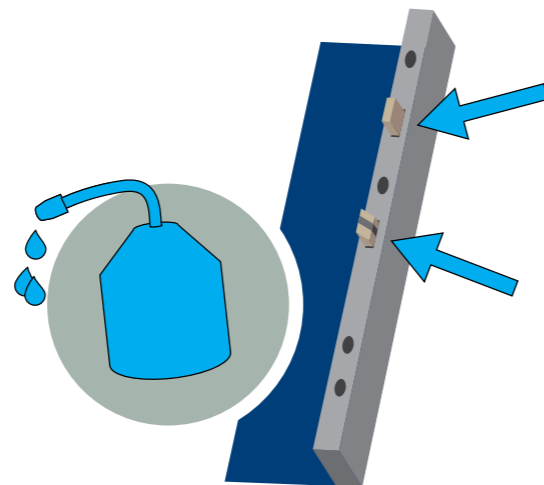

#### DOOR HINGES

In general, hinges are maintenance free and don't need to be greased.

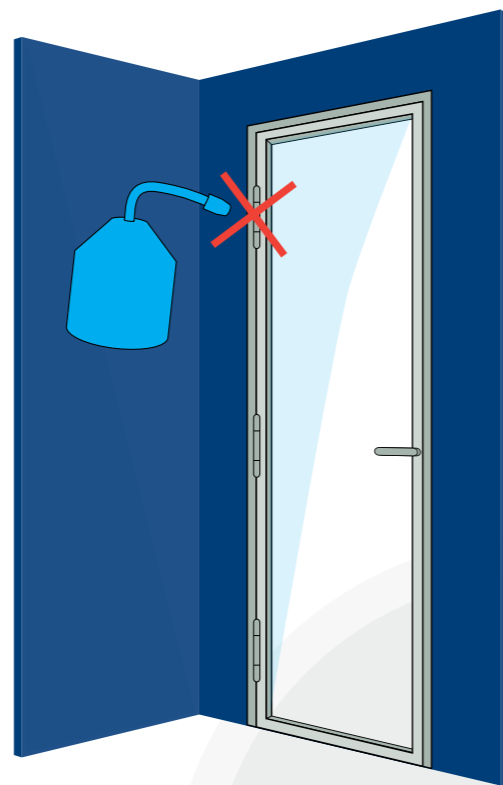

#### DOOR CLOSERS

Safety elements of door closers must be checked for wear regularly to ensure that they are fitted correctly and securely. Fixing screws must be tightened and any damaged components must be changed.

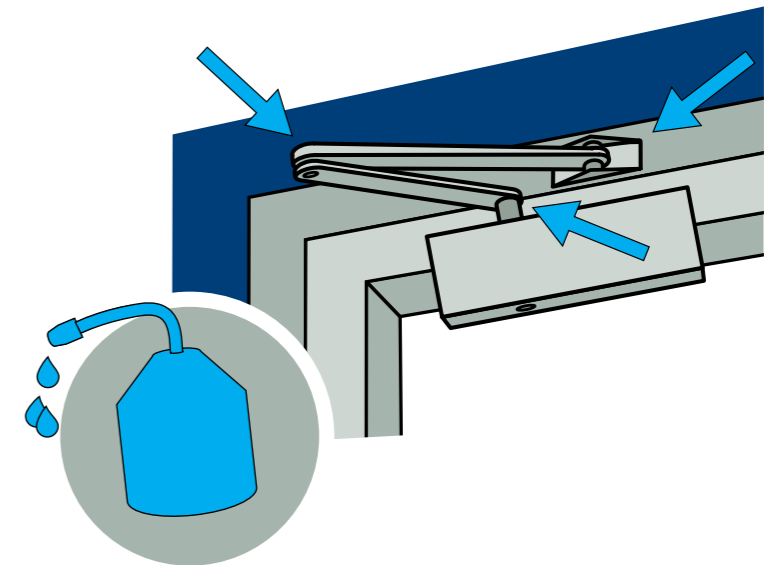

The frequency depends on opening type and environment, please check specifications in chapter 4.2 . Furthermore, the following maintenance work must be performed at least once a year (depending on the type of hinged leaf doors and their applications).

- All moving parts on the link arm must be greased
- The closer settings (e.g. closing speed) must be checked
- Smooth operation of the door must be checked
- In the case of door closers with special functions(hold-open devices/ hold-open systems), the legal check, monitoring, and maintenance must be observed
- Door closers and / or defective parts must be replaced immediately if their proper function is no longer guaranteed.

Only cleaning agents without corrosive and damaging components should be used.

## 4.5.2. SLIDING DOOR

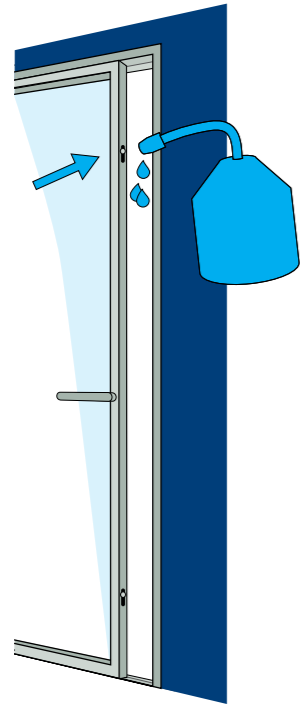

### SLIDING ELEMENT

All safety aspects of the gear, more specifically the fixings of the (lock, lock keeps, hook keeps and door handles), should be checked regularly. All gear adjustments, especially of the keeps and roller assemblies, the replacement of parts and installation and removing of the sashes should be executed by a window expert. Maintenance should be carried out at suitable intervals (see point 4.2) relative to the amount of use and environmental conditions.

Follow these instructions:

- Check the operation of the components.
- Any dust and dirt must be removed from the components as this could affect the smooth operation of the system.
- Clean the mechanism and remove any traces of dirt. Use a soft cloth and mild, pH-neutral cleaning materials in diluted form.
- After cleaning the hardware surface, treat it with silicone and corrosion free (i.e. nonacidic) oil.

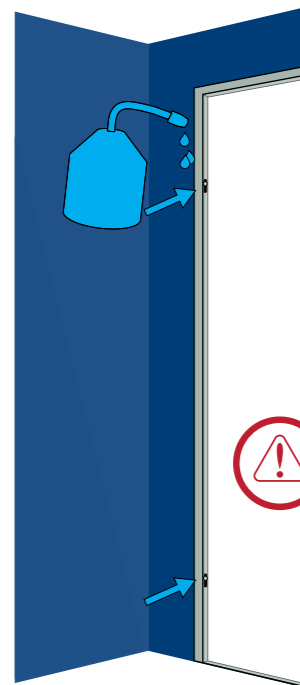

### LIFT & SLIDE ELEMENT

To ensure the smooth and trouble free operation, you must carry out the following maintenance instructions at least once a year:

- Lubricate or oil all locking parts.
- Use only clean and non-resinous grease or oil.
- After cleaning the hardware surface, treat it with silicone and corrosion free (i.e. non-acidic) oil.



#### WARNING!

The following work should only be performed by an authorized specialist:

- The replacement of fittings
- The assembly/dismantling of sashes

### THERMO FRONT

These maintenance instructions should be performed once every year.

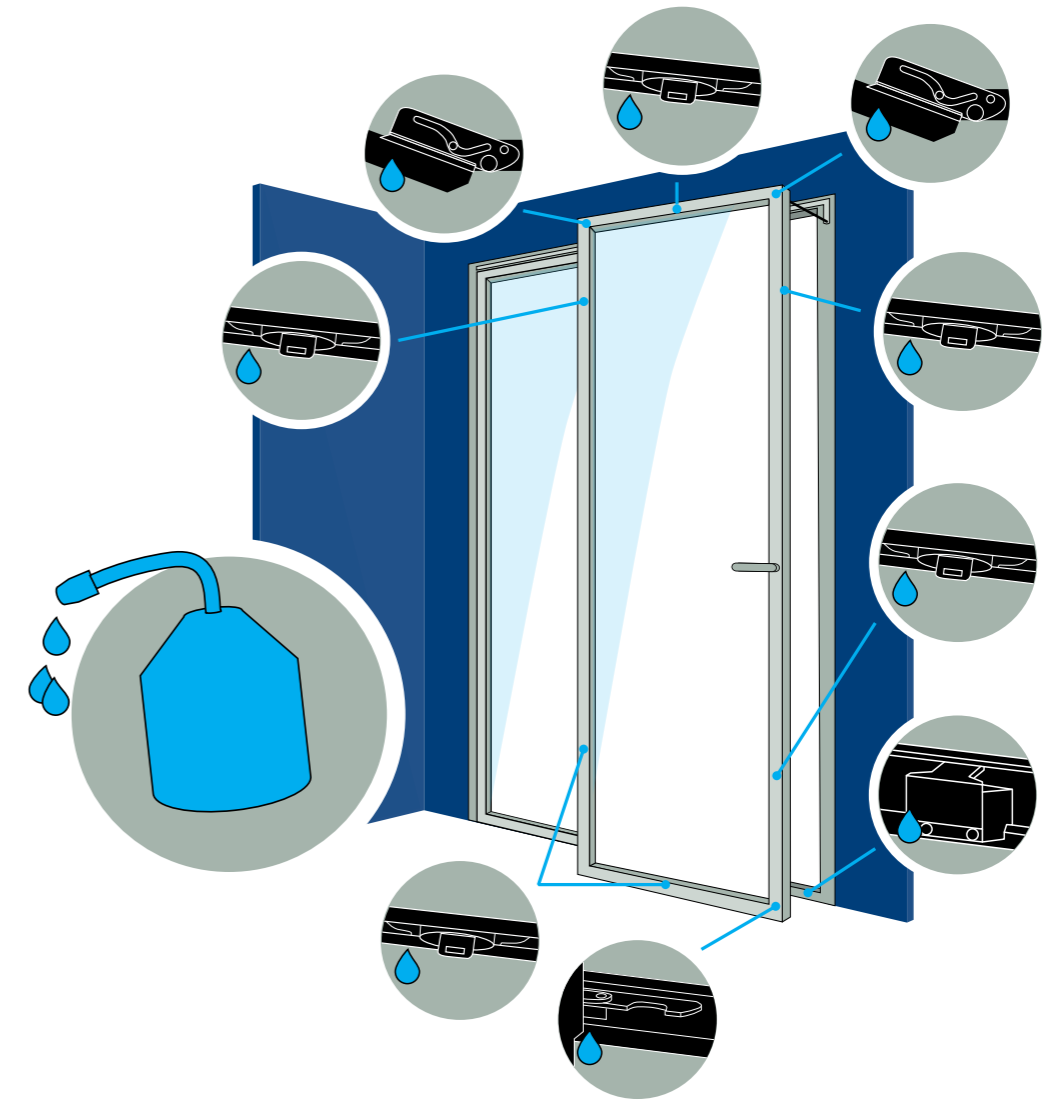

## 4.6. CLEANING AND MAINTENANCE OF OTHER SYSTEMS

### 4.6.1. VENTALIS



1. Open the flap of the ventilation grid completely
2. Open the flap of the ventilation grid completely and clean the inside using a vacuum cleaner and/or damp cloth.

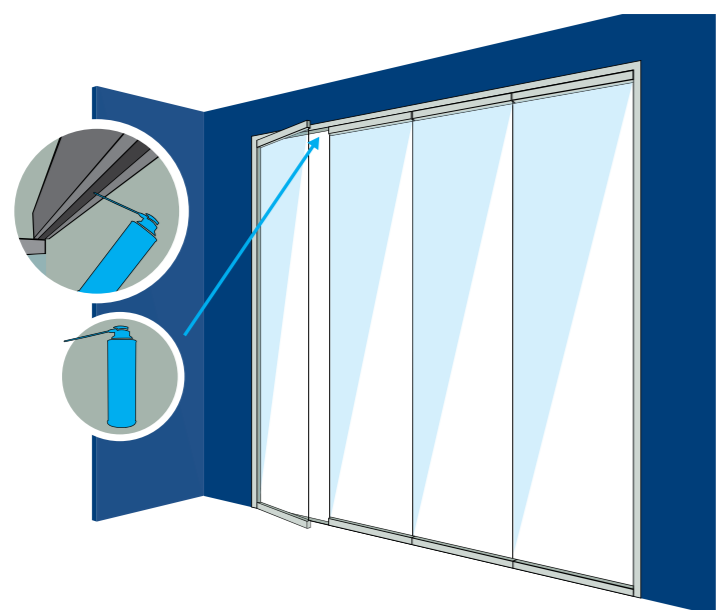

### 4.6.2. GP 51

The following operations must be carried out once a year:

Clean the inner rail on top of the GP 51 system with a cloth and spray the inner side of the rail with Teflon spray

## 4.7. CARE PRODUCTS

To ensure a lifelong and optimal functioning of your window -and door elements, Reynaers provides a complete range of care products for aluminium profiles. Here is an overview of our care product range with a brief product description. Remember to carefully read the instructions on the product labels.

### CLEANING

#### REYNAERS CLEAN & CARE WAX

- The ultimate product to clean and maintain profiles and glass
- 2 times per year in rural environments and on elements that are exposed to rain; 4 times per year in aggressive surroundings like Coastal, Industry, Railway, City Centers

Art. Nr: 086 9234 / 500 ml / Sold per one

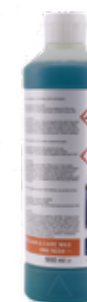

#### REYNAERS SPONGE & WIPE

The sponge

- removes persistent stains from powder coated profiles and anodized profiles
- can be re-used many times

The wipe

- has excellent cleaning properties
- has excellent absorption properties

Art. Nr: 086 9236 / 1 of each / Sold per package



#### REYNAWASH COLOR

- Colour cleaner for periodical application and maintenance.
- For all surfaces, including texture coating, powder-coated and film-laminated frames, as well as the glass surfaces
- Accurate and easy dosage
- Solvent-free
- Ph-neutral

Art. Nr: 086 9212 / 500 ml / Sold per one



#### REYNAWASH ANO

- Adds new shine to older profiles
- Cream cleaner for periodical application
- For all anodized aluminium surfaces
- Solvent-free

Art. Nr: 086 9213 / 500 ml / Sold per one



## LUBRICATING

### REYNAERS LUBRICANT

- Lubricates systems (windows, doors, sliding windows) and parts (rails and brushes of sliding systems)
- Use on average once a year, more in case of frequent use

Art. Nr: 086 9233 / 400 ml / Sold per one



## RENEWING

### REYNAERS DEEP CLEAN

- User-friendly cleaner of organic residue, insects, grease, dirt, resins, ...
- Very suitable for cleaning large surfaces (e.g. before hand-over of the building)
- Reynaers Deep clean will release the dirt so it can be easily removed
- Recommended for use after a long period of not maintaining or cleaning the elements

Art. Nr: 086 9238 / 1000 ml / Sold per one



### REYNAERS RE-NEWER

- Re-news the surface of Aluminium profiles
- Brings back the original intensity of the surface treatment
- Protect against UV-wear
- Nourishes the powder coated and anodized surfaces of profiles

Art. Nr: 086 9235 / 400 ml / Sold per one



### REYNOVATOR 718

- All-in-one total renovation oil used for restoration, conservation and maintenance of already installed aluminium surfaces (powder-coated and anodized)
- Protection against corrosion
- Adds shine
- Originates treating protective film

Art. Nr: 086 9211 / 500 ml / Sold per one



### REYNASTICK

- Touch up stick
- For powder coated profiles
- Available in all RAL colours

Art. Nr: 086 9600 XX / 12 ml / Sold per one





## 5. IMPORTANCE OF CLIMATE CONTROL AND VENTILATION

### 5.1 AIR TIGHTNESS COMBINED WITH GOOD VENTILATION

The Reynaers windows, doors and sliding systems are designed to be airtight. This means that, in closed position, almost no air circulation is caused by natural draught through the windows. However, water vapour is generated by daily activities in the house like cooking, showering and the inhabitants themselves. This vapour can cause condensation on walls and windows and, in a further evolved stage, cause stains, fungus and decaying of the plaster wall. To avoid the negative effects of the moist, rooms should be well ventilated.

This can be achieved as follows:

1. Opening the window completely for a few minutes every day
2. Put it in a tilt position for a longer time
3. Install a Ventalis (intelligent ventilation grid) on top of the window/sliding system for continuous controlled ventilation.

### 5.2 VENTILATION AND CLIMATE CONTROL

1. To avoid loss of heating energy long-term uncontrolled draught should be avoided. Putting the window on a tilt position during winter time is therefore not recommended.
2. Short term maximal ventilation of the room, by opening the window completely, has less effect on the heat loss and is preferred above long term, uncontrolled ventilation.
3. Controlled ventilation with Ventalis defines a maximal airflow through the grid and closes off automatically with high wind pressures to avoid draught. Positioned in the dry areas of the home (bedroom, living room), fresh air flows in. Typically the bathroom and kitchen have extractors that pull the fresh air through the house and push the moist air outside. This Ventalis solution provides fresh air all day/night long, limits the heat loss while offering a secure solution (anti burglary).

## 6. RECOMMENDATIONS

### REYNAERS RECOMMENDATIONS :

1. It is extremely important that repair works are performed by the supplier of your systems. In this way the system guarantee remains preserved. Your Reynaers professional disposes of qualified personnel and specialized tooling for the required maintenance or reparation works.
2. Hardware parts of the Reynaers system should only be replaced by the original parts provided by your Reynaers installer.
3. In case this manual does not provide an answer to all your questions, please contact your local Reynaers professional. He can give you detailed advice on the operation, care and maintenance of your Reynaers window and door systems.
4. During maintenance activities, the physical properties should be considered. Especially the direct contact between glass, sealing components, silicone and façade elements.



## ABOUT REYNAERS ALUMINIUM

Reynaers Aluminium is a leading European specialist in the development and marketing of innovative and sustainable aluminium solutions for windows, doors, curtain walling, sliding systems, sunscreening and conservatories. Besides offering an extensive range of standard solutions, the company also develops solutions that are tailored to the individual customer or project. Research, product development and testing are conducted at the Reynaers Campus, the sector's largest private innovation and testing centre, located in Duffel (Belgium). In addition, the company also provides extensive technical support and advice to fabricators, contractors and architects.

Reynaers Aluminium is the market leader in Belgium and has acquired a strong market position worldwide. The company's success is due in part to the close partnership between Reynaers Aluminium and 5,000 partner fabricators, architects and project developers worldwide.

Reynaers Aluminium is founded in 1965 and is part of the group Reynaers, currently employing over 2200 workers in more than 40 countries worldwide and exporting to more than 70 countries on 5 continents. The company achieved an annual turnover of 537 million euros in 2018.

For more information, visit [www.reynaers.com](http://www.reynaers.com)



## TOGETHER FOR BETTER

[WWW.REYNAERS.COM](http://WWW.REYNAERS.COM)